



**SERIES VLB325/VLB335**



Series VLB325  
Series VLB335



PED 2014/68/EU, article 4.3

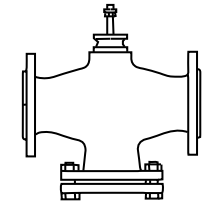
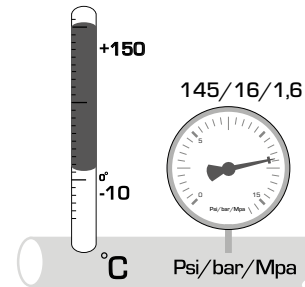

Series VLB325

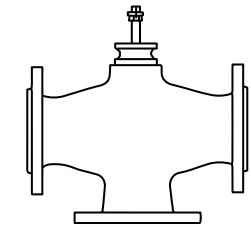

Series VLB335

Mtrl.nr: 9814 09 21 • Ritn.nr: 6286 utg. B • Rev. 1608

**1**

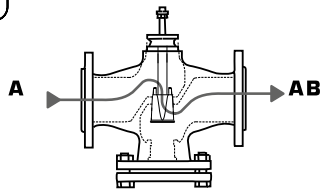

VLB325

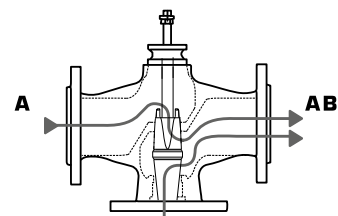

VLB335

**2**

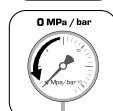
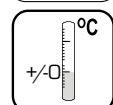

1/2/3/4/5/6/7/8 = 50%  
9/10/11/12/13/14/15/16 = 100%

M

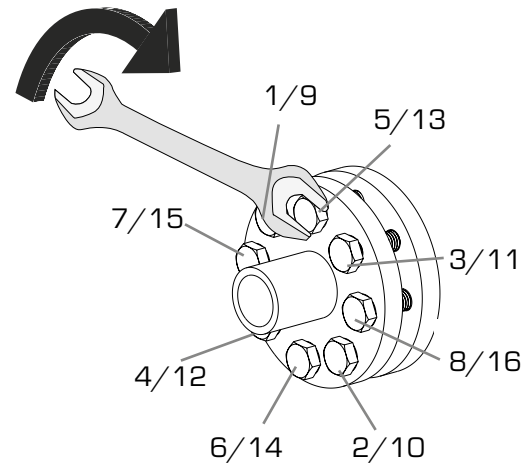

**3**

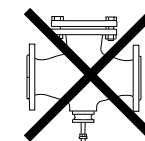
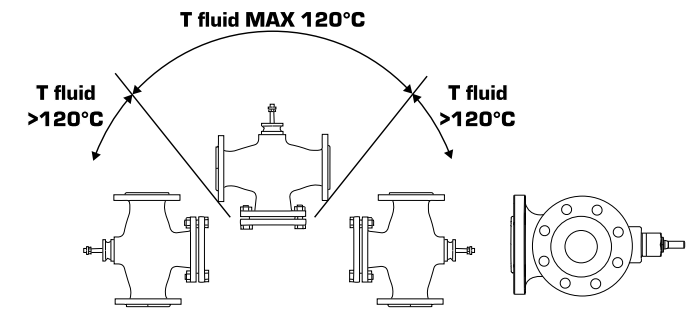

**4**

VLB325

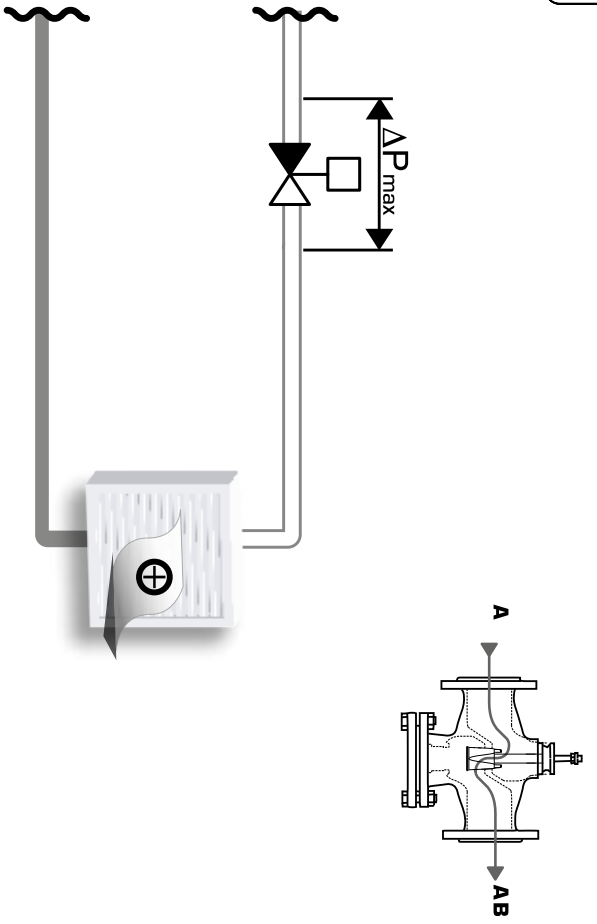
**5**

VLB325

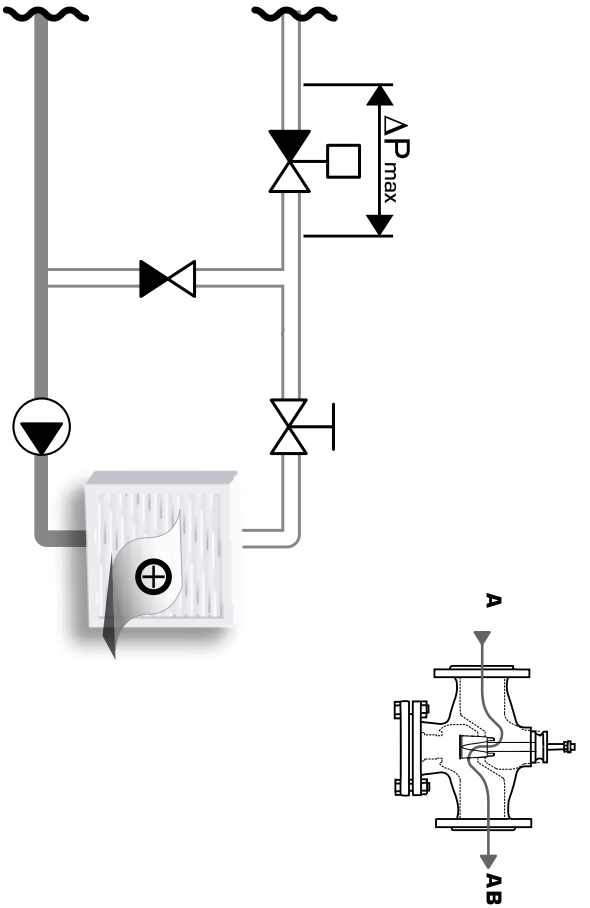
**6**

VLB335

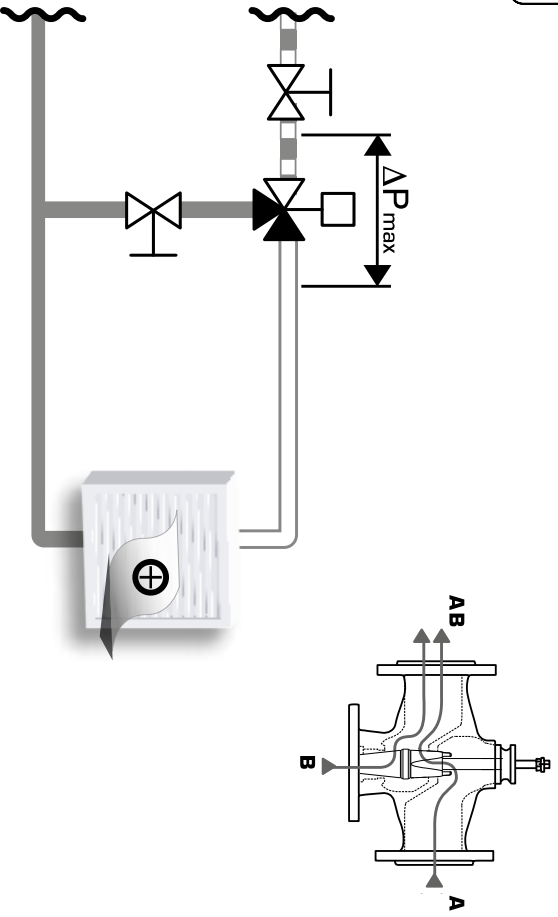
**7**

VLB335

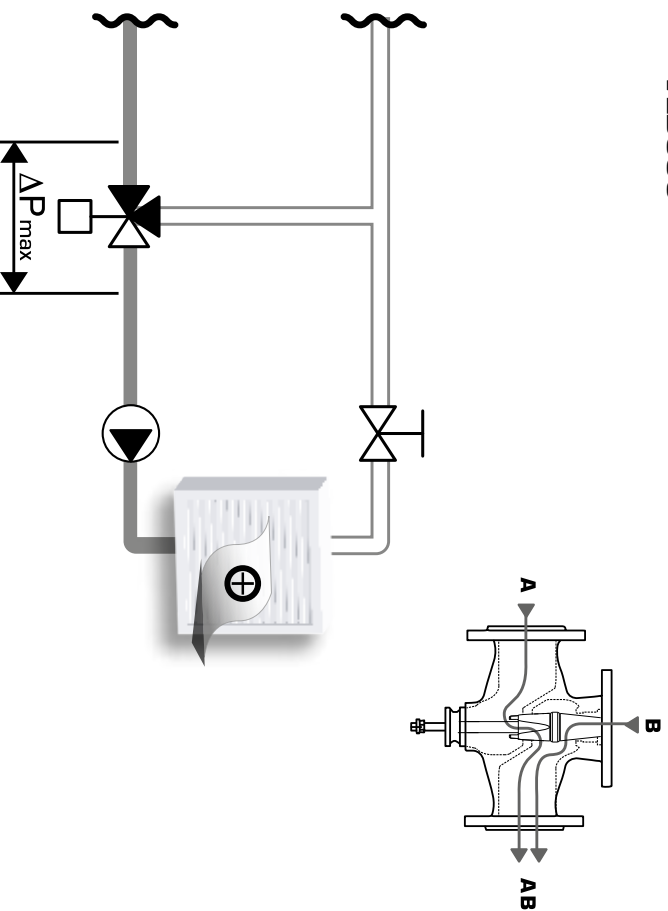

Piping Schematics are General Representations