



SERIES VRG230



Mtrl.nr. 9814 02 72 • Ritn.nr. 7048 utg C • Rev. 1605



Series VRG231
Series VRG232
Series VRG233
Series VRG238

CE
PED 2014/68/EU, article 4.3

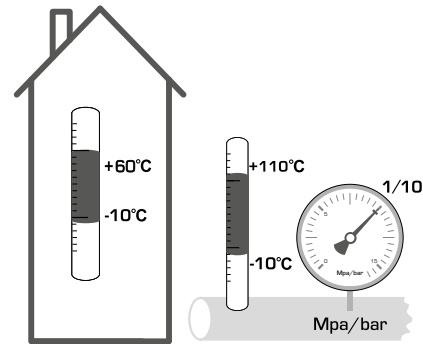

1

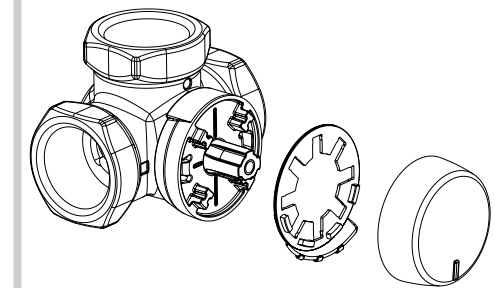

i

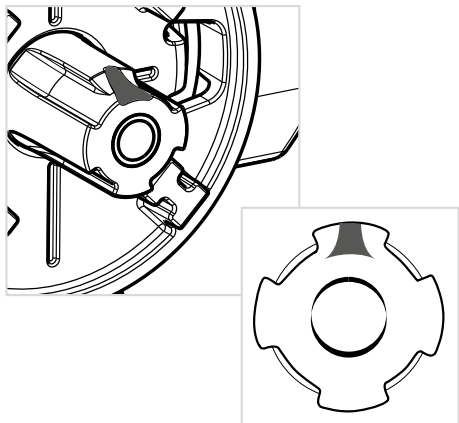

i

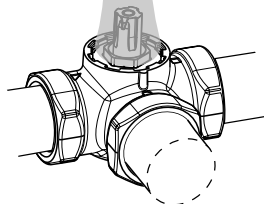
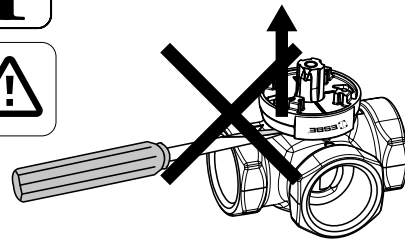

Piping Schematics are General Representations

2

a

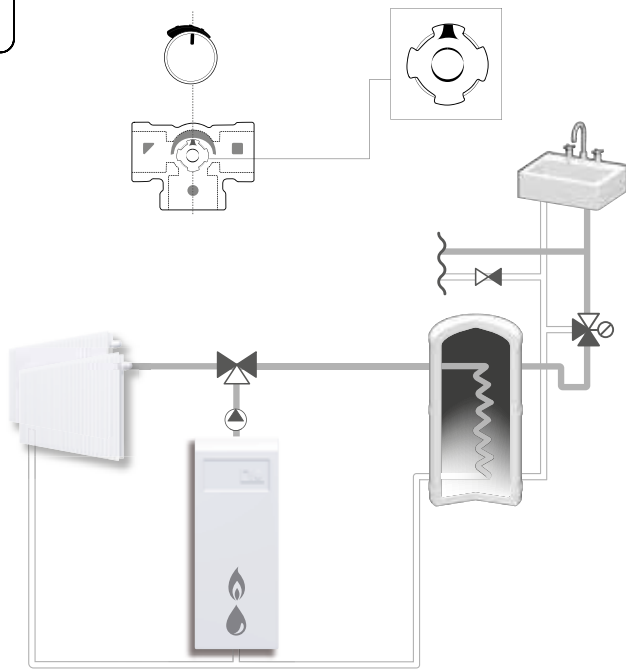

b

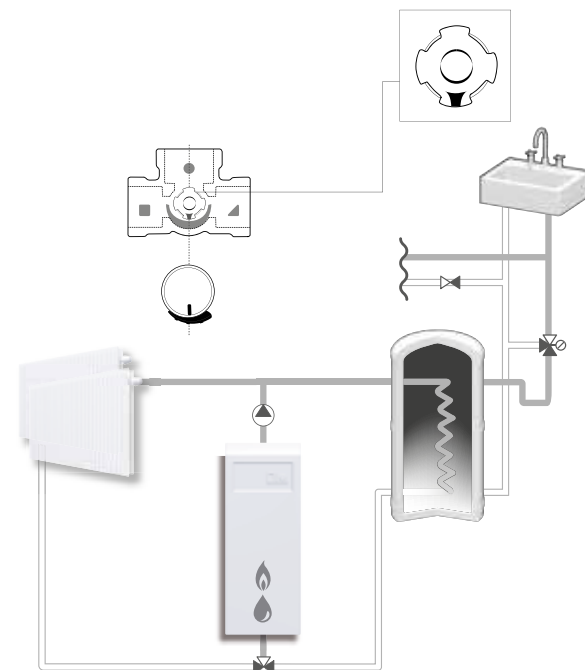

i



<http://www.esbe.eu/global/en/products/rotary-valves>