

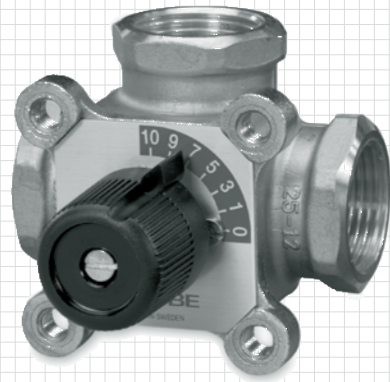

www.esbe.se



**SERIES MG, G, F**



**NO.1 IN HYDRONIC SYSTEM CONTROL**



Series 3MG, 4MG  
Series 3G, 4G  
Series 3F, 4F  
CE  
PED 97/23/EC

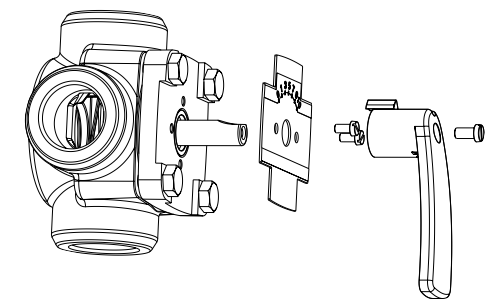
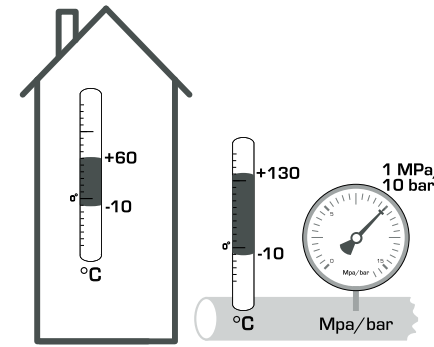
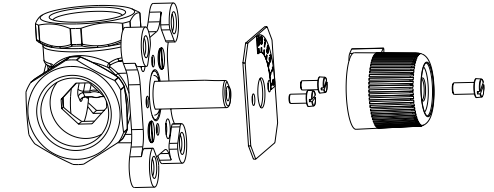

Mtrl.nr. 9814 00 47 • Ritn.nr. 4218 utg. C • Rev. 0803

**Series 3MG, 3G, 3F**

1a

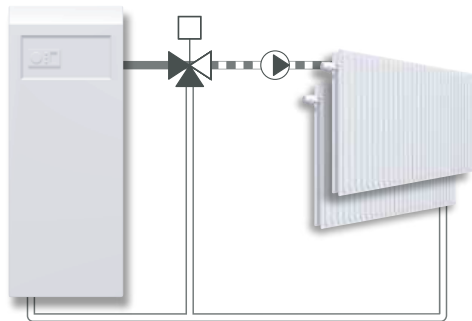
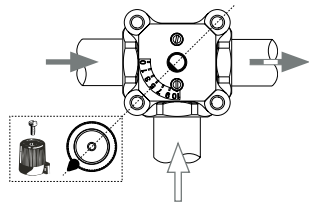

1b

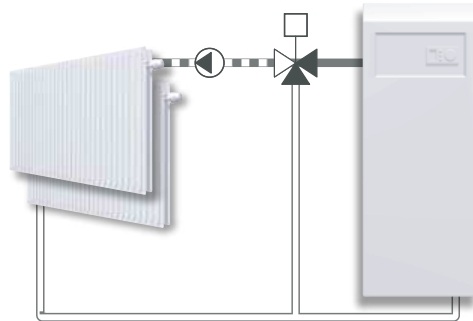
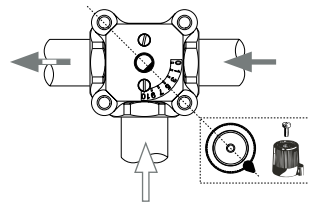

2a

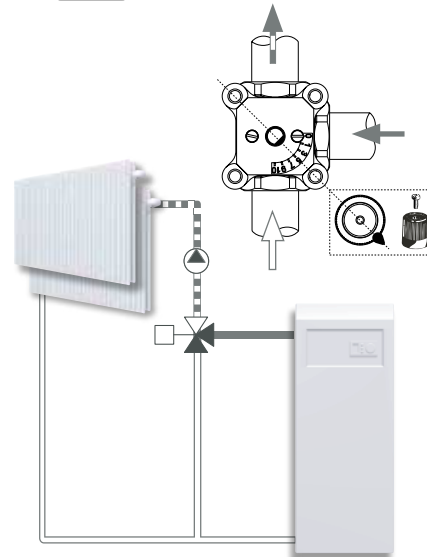

2b

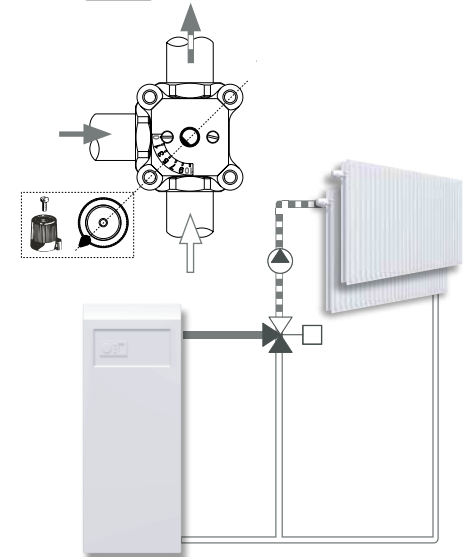

Series 3MG, 3G, 3F

3a



3b

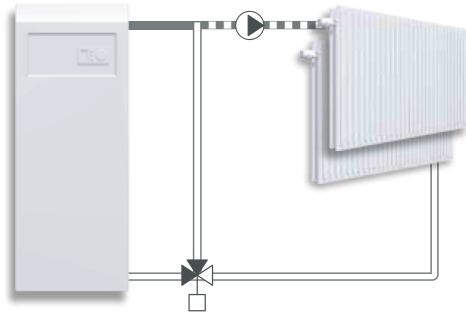
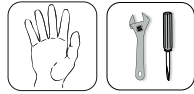

4a

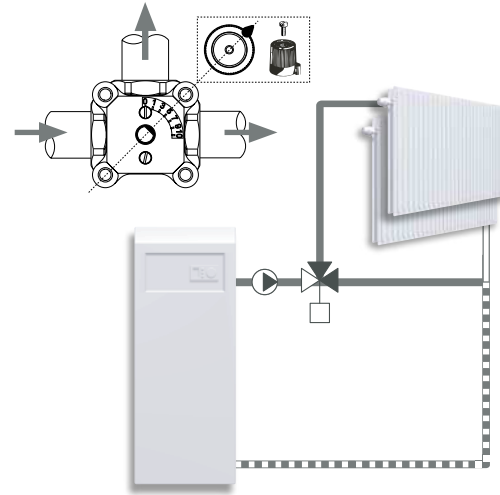

4b

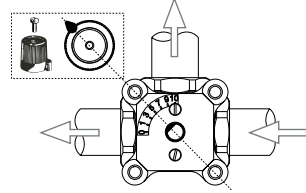
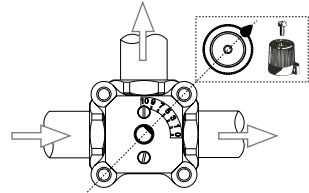
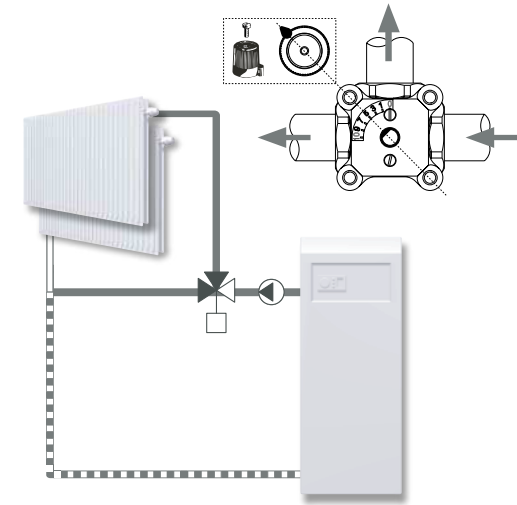

Series 4MG, 4G, 4F

5a

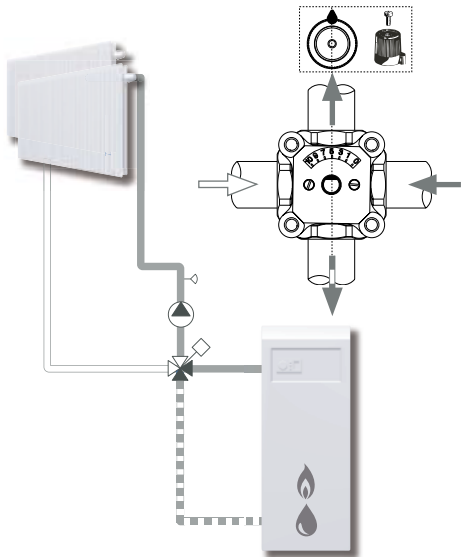

5b

