

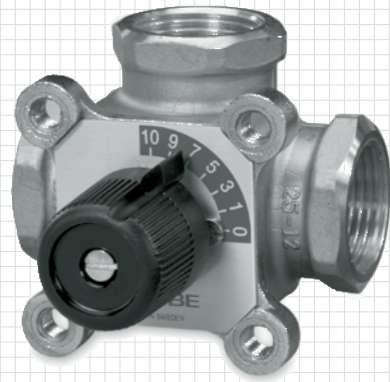

www.esbe.se



SERIES MG, G, F



NO.1 IN HYDRONIC SYSTEM CONTROL



Series 3MG, 4MG
Series 3G, 4G
Series 3F, 4F
CE
PED 97/23/EC

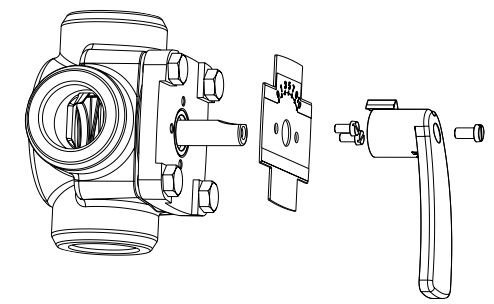
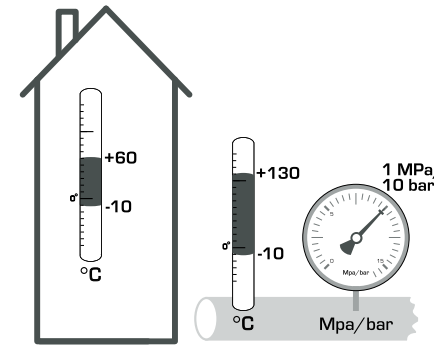
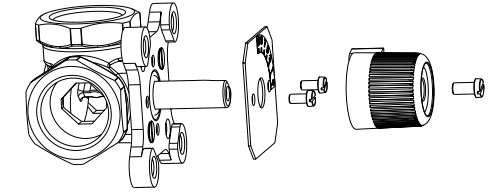

Mtrl.nr. 9814 00 47 • Ritn.nr. 4218 utg. C • Rev. 0803

Series 3MG, 3G, 3F

1a

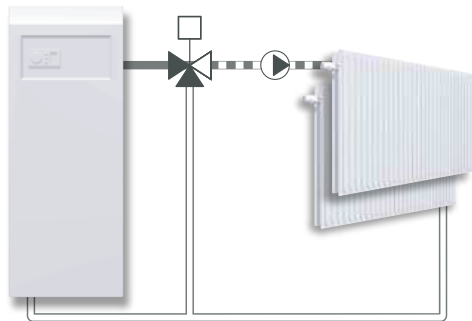

1b

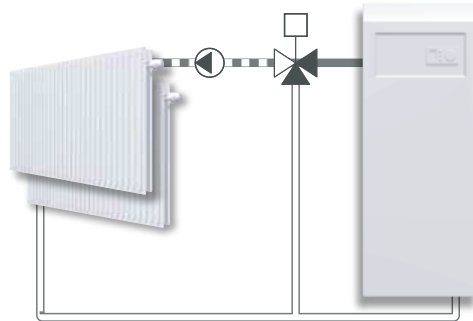
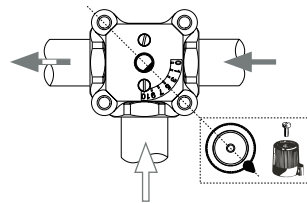

2a

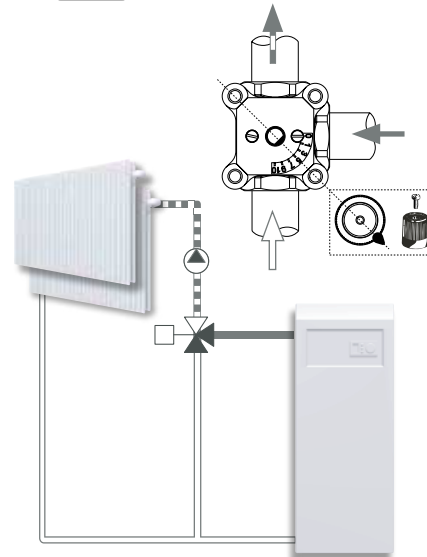

2b

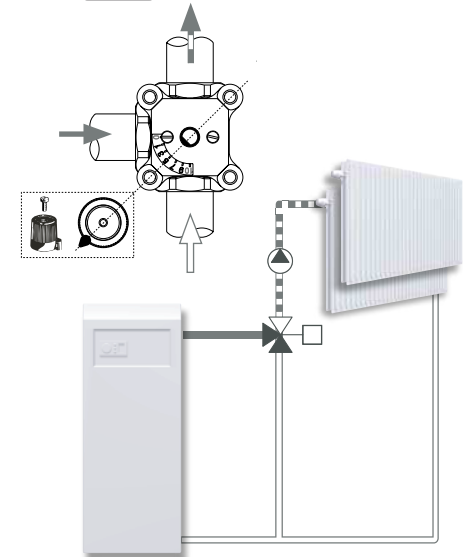

Series 3MG, 3G, 3F

3a



3b

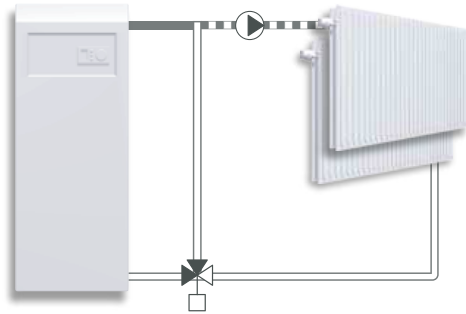
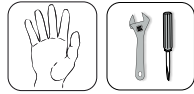

4a

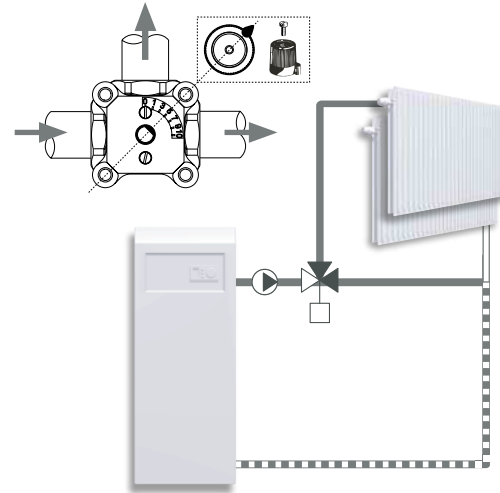

4b

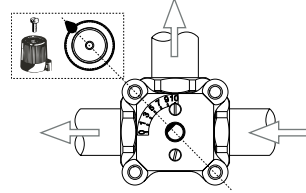
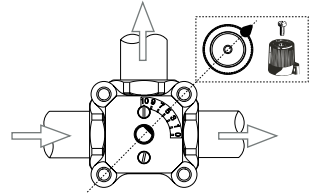
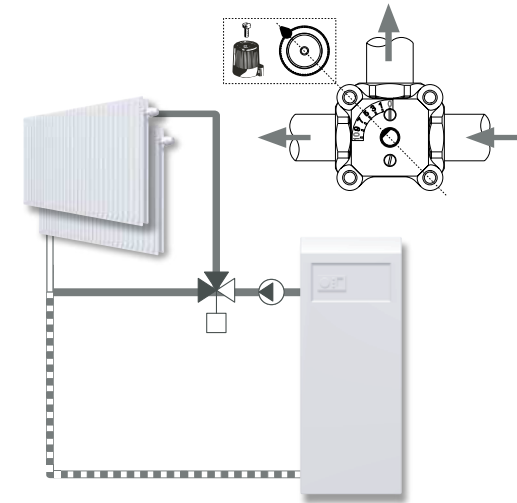

Series 4MG, 4G, 4F

5a

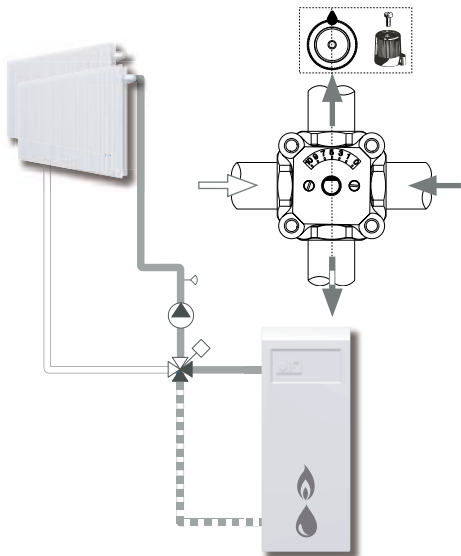

5b

