

ESBE SYSTEM UNITS – ACCESSORIES

MANIFOLD



GB

MANIFOLD 2-3

SE

FÖRDELNINGSBALK 4-5

DE

VERTEILERBALKEN 6-7

PL

ROZDZIELACZ 8-9

IT

COLLETTORE 10-11

FR

COLLECTEUR 12-13

RU

КОЛЛЕКТОР 14-15

EE

KOLLEKTOR 16-17

LT

KOLEKTORIUS 18-19

LV

KOLEKTORS 20-21

CZ

ROZDĚLOVACÍ ČLEN 22-23

SI

RAZDELILEC 24-25

FI

JAKOTUKIT 26-27





SERIES	FUNCTION	
ESBE GMA121		<p>Manifold for 2 Circulation Units, without integrated hydraulic separator function.</p>
ESBE GMA131		<p>Manifold for 3 Circulation Units, without integrated hydraulic separator function.</p>
ESBE GMA221		<p>Manifold for 2 Circulation Units, with integrated hydraulic separator function.</p>
ESBE GMA231		<p>Manifold for 3 Circulation Units, with integrated hydraulic separator function.</p>
ESBE GMA321		<p>Manifold for 2 Circulation Units, without integrated hydraulic separator function.</p>
ESBE GMA331		<p>Manifold for 3 Circulation Units, with integrated hydraulic separator function.</p>



MULTIPLE INSTALLATIONS OF CIRCULATION UNITS

If more than one Circulation Unit should be used we recommend the use of Serie ESBE GMA manifold, with or without hydraulic separator.

INSTALLATION ON THE WALL

Install the appliance on a solid wall which is not subject to vibration. It's important to position the hydraulic manifold considering its size and all the units connected.

When drilling holes in the wall for installation purposes, take care not to damage any electrical wiring or existing piping.

1. Drill holes and insert suitable plugs.

Mount the manifold with the submitted wall-brackets. Fix the brackets to the wall and position the manifold.

2. Choose the correct position for the piping for the circulation unit by usage of the mounting template supplied with the circulation units package.

3. Connect the circulation units to the manifold.

1 GMA121, GMA131, GMA221, GMA231

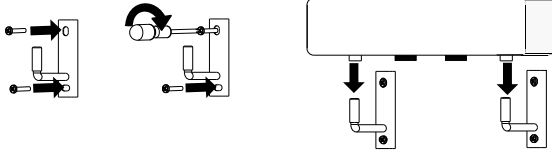

1 GMA321, GMA331

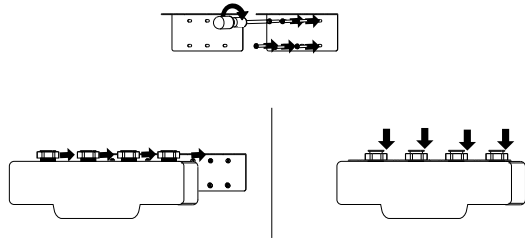

2 GMA121, GMA131, GMA221, GMA231, GMA321, GMA331

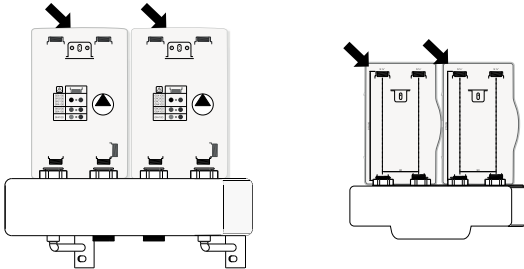

3 GMA121, GMA131, GMA221, GMA231, GMA321, GMA331

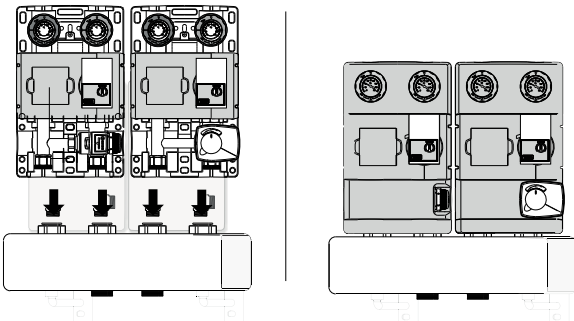

INSTALLATION EXAMPLE

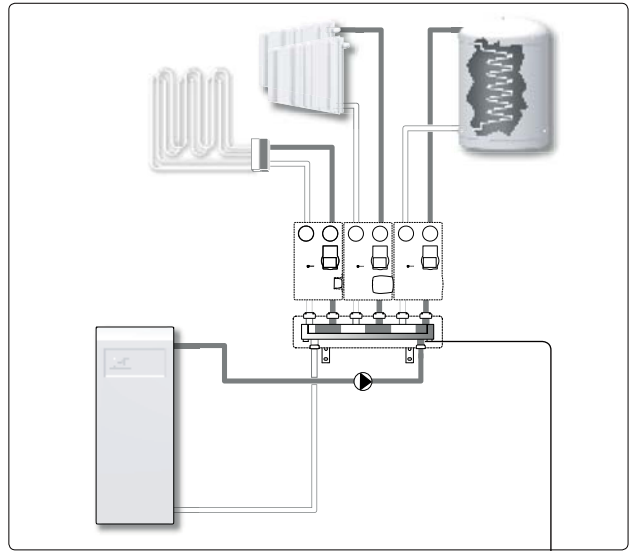

GMA121, GMA131, GMA221, GMA231

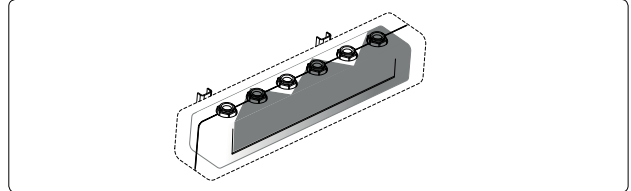

OPTIONS FOR GMA221 AND GMA231

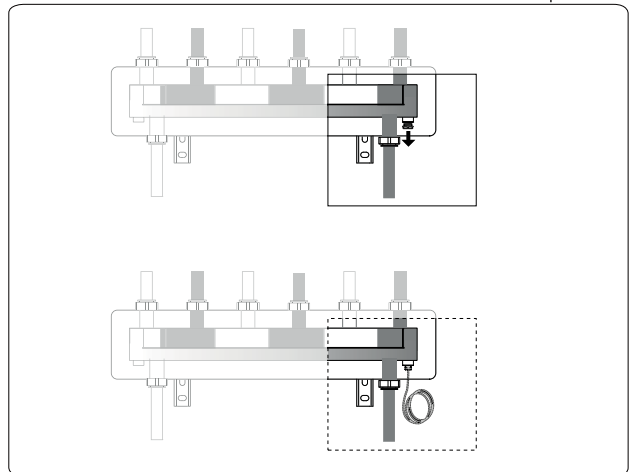

All piping schematics are general representations.



www.esbe.eu



NO.1 IN HYDRONIC SYSTEM CONTROL

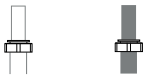
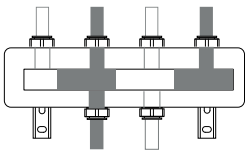
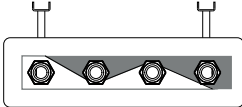
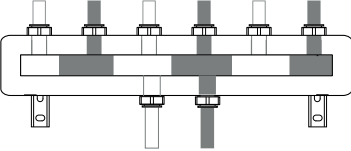
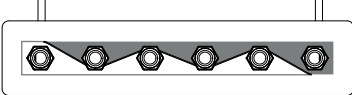
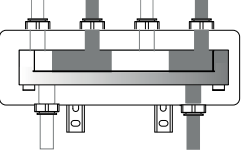
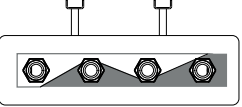
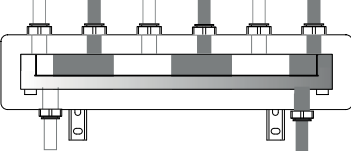
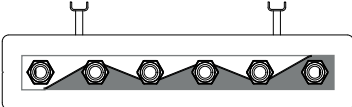
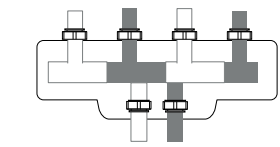
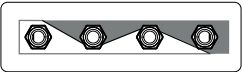
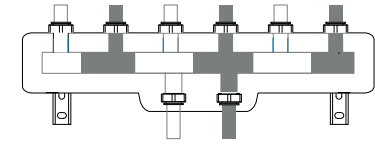
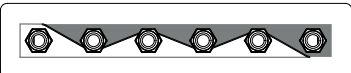

SERIE	FUNKTION Retur Tillförsel 	
ESBE GMA121	 	Fördelarbalk för 2 pumpgrupper, utan hydraulisk inbyggd separatorfunktion.
ESBE GMA131	 	Fördelarbalk för 3 pumpgrupper, utan hydraulisk inbyggd separatorfunktion.
ESBE GMA221	 	Fördelarbalk för 2 pumpgrupper, med hydraulisk inbyggd separatorfunktion.
ESBE GMA231	 	Fördelarbalk för 3 pumpgrupper, med hydraulisk inbyggd separatorfunktion.
ESBE GMA321	 	Fördelarbalk för 2 pumpgrupper, utan hydraulisk inbyggd separatorfunktion.
ESBE GMA331	 	Fördelarbalk för 3 pumpgrupper, utan hydraulisk inbyggd separatorfunktion.



MULTIPLA INSTALLATIONER AV PUMPGRUPPER

Om fler än en pumpgrupp ska installeras rekommenderar vi att du använder fördelarbalk i serien ESBE GMA, med eller utan hydraulisk separator.

INSTALLATION PÅ VÄGGEN

Installera anordningen på en stabil vägg som inte är föremål för vibrationer. Det är viktigt vid placering av den hydrauliska fördelarbalken att beakta storlek och vikt av alla anslutna enheter.

Var försiktig när du borrar hål i väggen för installationen så att du inte skadar elektriskt kablage eller befintliga ledningar.

1. Borra hål och sätt i lämpliga pluggar.

Montera fördelarbalken med de medföljande vägghållarna. Fäst hållarna på väggen och placera fördelarbalken.

2. Välj rätt position för anslutande ledningar mot pumpgruppen genom att använda monteringsmallen som finns i pumpgruppens förpackning.

3. Anslut pumpgrupperna till fördelarbalken.

1 GMA121, GMA131, GMA221, GMA231

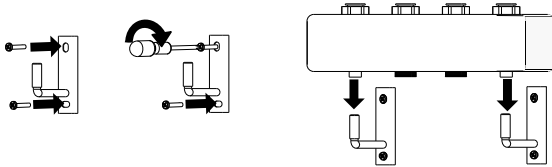

1 GMA321, GMA331

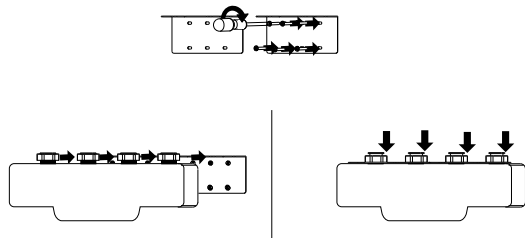

2 GMA121, GMA131, GMA221, GMA231, GMA321, GMA331

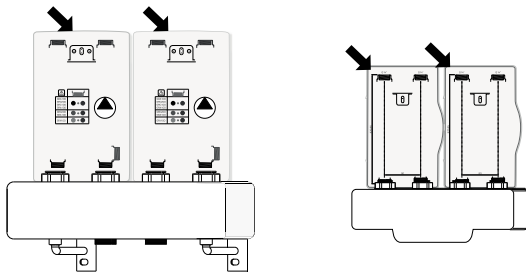

3 GMA121, GMA131, GMA221, GMA231, GMA321, GMA331

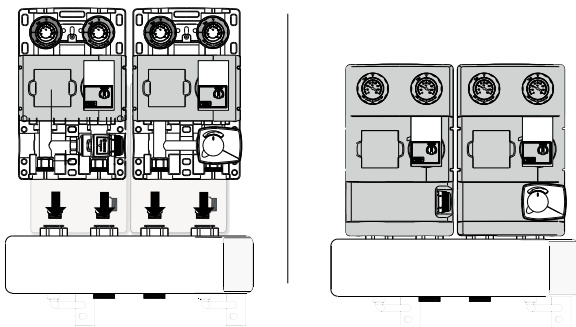

INSTALLATIONS EXEMPEL

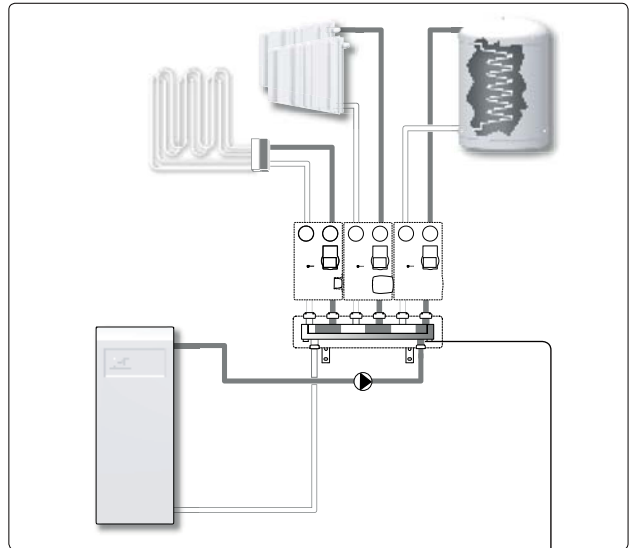

GMA121, GMA131, GMA221, GMA231

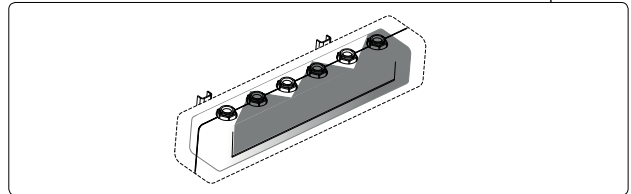

ALTERNATIV FÖR GMA221 OCH GMA231

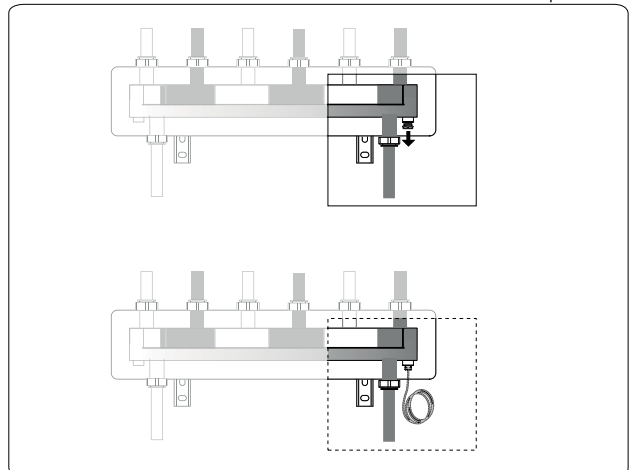

Alla installationsexempel är allmänna beskrivningar.



www.esbe.eu



NO.1 IN HYDRONIC SYSTEM CONTROL

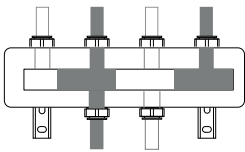
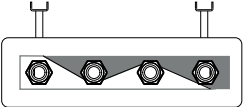
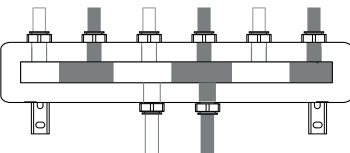
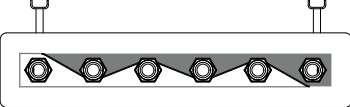
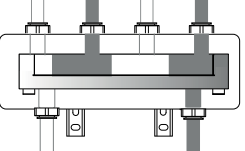
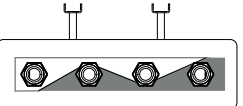
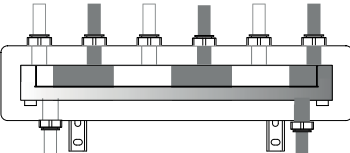
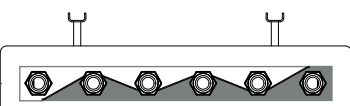
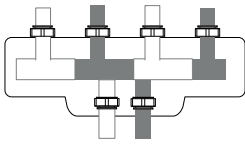
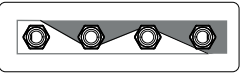
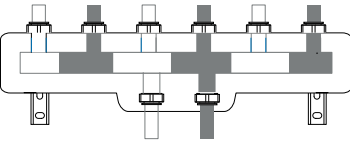
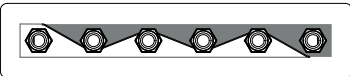

SERIE	FUNKTION Rücklauf Vorlauf 	
ESBE GMA121	 	Verteilerbalken ohne hydraulische Weiche für zwei Pumpengruppen.
ESBE GMA131	 	Verteilerbalken ohne hydraulische Weiche für drei Pumpengruppen.
ESBE GMA221	 	Verteilerbalken mit hydraulischer Weiche für zwei Pumpengruppen.
ESBE GMA231	 	Verteilerbalken mit hydraulischer Weiche für drei Pumpengruppen.
ESBE GMA321	 	Verteilerbalken ohne hydraulische Weiche für zwei Pumpengruppen.
ESBE GMA331	 	Verteilerbalken ohne hydraulische Weiche für drei Pumpengruppen.



MONTAGE DES VERTEILERBALKENS

Für die Installation von zwei oder drei Pumpengruppen empfiehlt sich die Verwendung der ESBE Verteilerbalken, die mit und ohne integrierte hydraulische Weiche zur Verfügung stehen.

MONTAGE

Vor Beginn der Montage sind die statischen Bedingungen des Einsatzortes zu überprüfen. Rohrleitungssysteme dürfen zu keiner unzulässig hohen Belastung führen. Der Verteilerbalken ist unter Berücksichtigung seiner Größe und der darauf zu montierenden Pumpengruppen zu positionieren. Achten Sie darauf, dass Sie beim Bohren keine elektrischen Leitungen oder bestehende Rohre beschädigen.

1. Bohren Sie die Löcher und setzen Sie die Dübel ein. Befestigen Sie die mitgelieferte Wandhalterung und setzen Sie anschließend den Verteilerbalken auf. Prüfen Sie vor der Montage, ob die (in den Pumpengruppen) mitgelieferten Schrauben und Dübel für Ihre Montagesituation geeignet sind. Um die Eignung einzuschätzen, berücksichtigen Sie den Wandaufbau sowie das Gewicht der gesamten Baugruppe und das des Wassers. Verwenden Sie bei Bedarf spezielles Befestigungsmaterial.
2. Wählen Sie anhand der im Paket der Pumpengruppen mitgelieferten Montagevorlagen die richtige Lage für Leitungen und Verschraubung aus.
3. Montieren Sie die Pumpengruppen auf den Verteilerbalken.

1 GMA121, GMA131, GMA221, GMA231

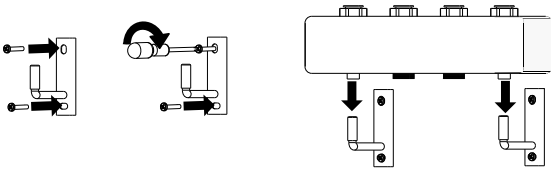

1 GMA321, GMA331

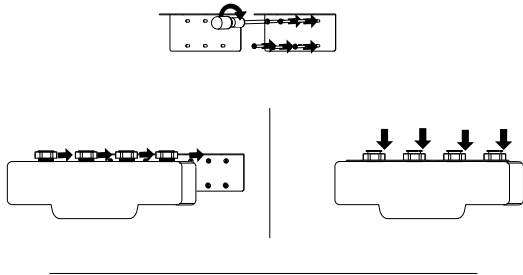

2 GMA121, GMA131, GMA221, GMA231, GMA321, GMA331

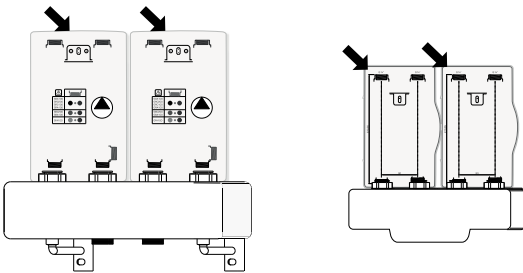

3 GMA121, GMA131, GMA221, GMA231, GMA321, GMA331

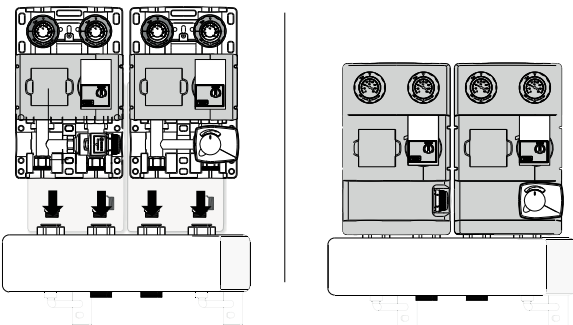

EINBAUBEISPIEL

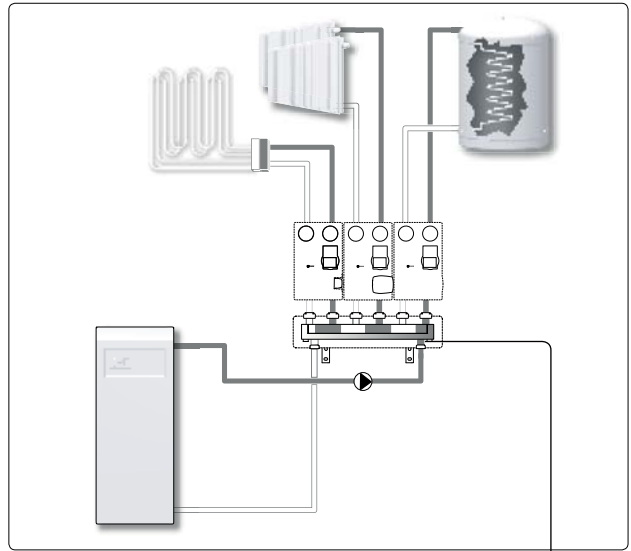

GMA121, GMA131, GMA221, GMA231

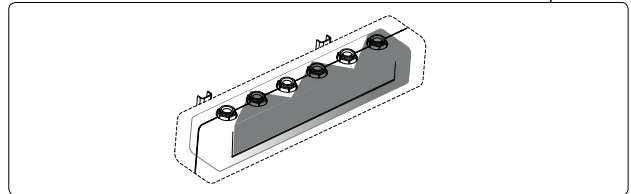

ZUSÄTZLICHE ANSCHLÜSSE GMA221 UND GMA231

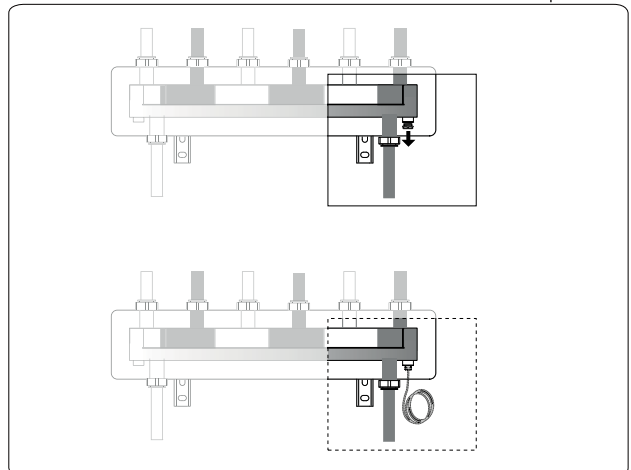

Alle Schalt- und Schaubilder sind lediglich allgemeine Darstellungen.



www.esbe.eu

ESBE

NO.1 IN HYDRONIC SYSTEM CONTROL



SERIA	FUNKCJA		
	Powrót	Zasilanie	
ESBE GMA121			Rozdzielacz do 2 obiegów grzewczych bez zintegrowanego sprzęgła hydraulicznego
ESBE GMA131			Rozdzielacz do 3 obiegów grzewczych bez zintegrowanego sprzęgła hydraulicznego
ESBE GMA221			Rozdzielacz do 2 obiegów grzewczych ze zintegrowanym sprzęgłem hydraulicznym
ESBE GMA231			Rozdzielacz do 3 obiegów grzewczych ze zintegrowanym sprzęgłem hydraulicznym
ESBE GMA321			Rozdzielacz do 2 obiegów grzewczych bez zintegrowanego sprzęgła hydraulicznego
ESBE GMA331			Manifold for 3 Circulation Units, without integrated hydraulic separator function.



MONTAŻ WIELU GRUP POMPOWYCH

Jeśli konieczne jest użycie więcej niż jednej grupy pompowej, zalecane jest zastosowanie rozdzielacza z serii ESBE GMA ze sprzęgłem hydraulicznym lub bez.

MONTAŻ NA ŚCIANIE

Urządzenie należy zamontować na wytrzymałej ścianie, w której nie występują wibracje. Ważne jest odpowiednie umiejscowienie rozdzielacza hydraulicznego z uwzględnieniem jego wielkości oraz wszystkich podłączonych do niego jednostek.

Podczas wiercenia otworów montażowych należy uważać, by nie uszkodzić przewodów elektrycznych ani rur.

1. Wywierć otwory i umieść w nich odpowiednie kołki rozporowe. Zamontuj kolektor za pomocą dostarczonych wsporników ściennych. Zamocuj wsporniki na ścianie i zamontuj na nich rozdzielacz.
2. Ustal odpowiednie rozmieszczenie rur grupy pompowej, korzystając z szablonu montażowego dostarczonego wraz z tym urządzeniem.
3. Podłącz grupy pompowe do rozdzielacza.

1 GMA121, GMA131, GMA221, GMA231

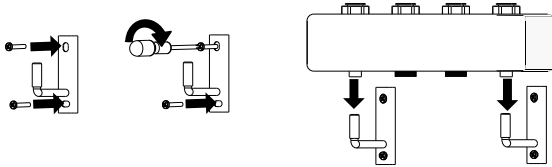

1 GMA321, GMA331

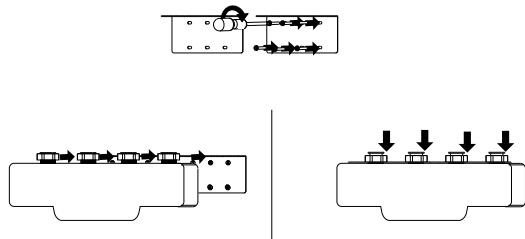

2 GMA121, GMA131, GMA221, GMA231, GMA321, GMA331

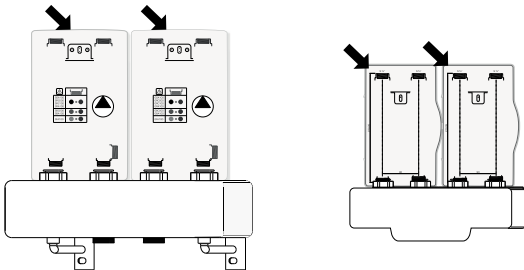

3 GMA121, GMA131, GMA221, GMA231, GMA321, GMA331

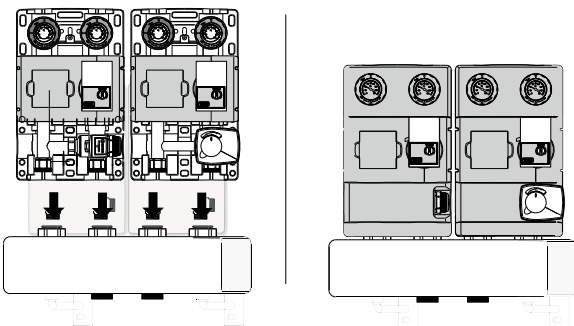

PRZYKŁADOWA INSTALACJA

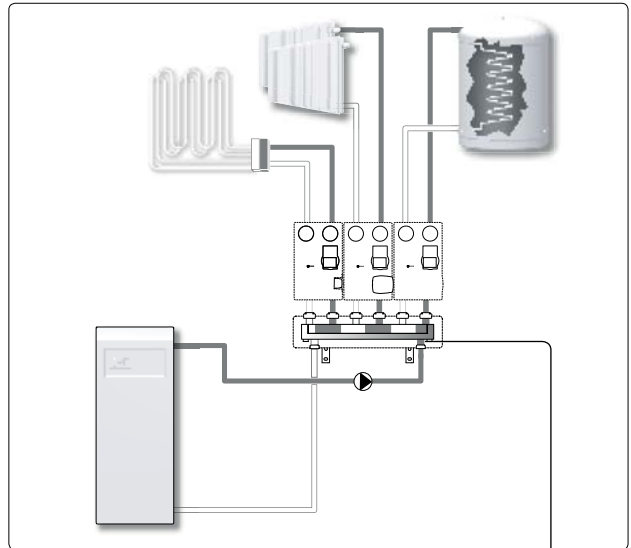

GMA121, GMA131, GMA221, GMA231

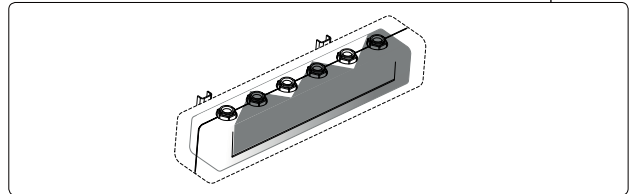

OPCJE DLA ROZDZIELACZY GMA221 ORAZ GMA231

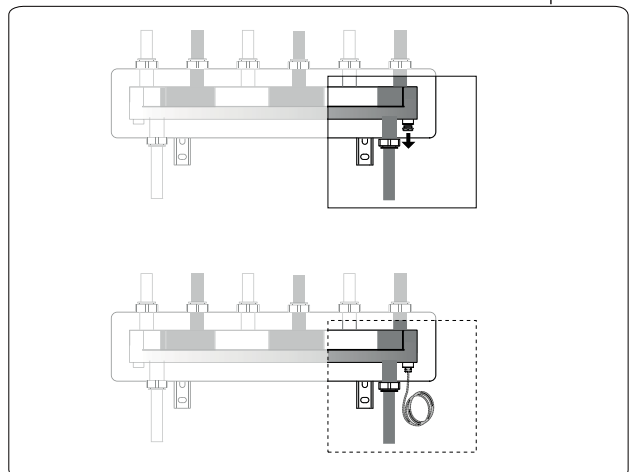

Wszystkie schematy połączeń rurowych są przykładami ogólnymi.



www.esbe.eu



NO.1 IN HYDRONIC SYSTEM CONTROL



SERIE	FUNZIONE		
	Ritorno	Mandata	
ESBE GMA121			Collettore per 2 gruppi di miscelazione, senza la funzione di separatore idraulico integrato.
ESBE GMA131			Collettore per 3 gruppi di miscelazione, senza la funzione di separatore idraulico integrato.
ESBE GMA221			Collettore per 2 gruppi di miscelazione, con la funzione di separatore idraulico integrato.
ESBE GMA231			Collettore per 3 gruppi di miscelazione, con la funzione di separatore idraulico integrato.
ESBE GMA321			Collettore per 2 gruppi di miscelazione, senza la funzione di separatore idraulico integrato.
ESBE GMA331			Collettore per 3 gruppi di miscelazione, senza la funzione di separatore idraulico integrato.



INSTALLAZIONI MULTIPLE DI GRUPPO DI MISCELAZIONE

Qualora si dovesse utilizzare più di un gruppo di miscelazione, si raccomanda l'uso dei collettori serie ESBE GMA, con o senza separatore idraulico. In mancanza di un serbatoio di accumulo installato, è da preferirsi un collettore con separatore.

INSTALLAZIONE A PARETE

Installare l'apparecchio su una parete solida, non soggetta a vibrazioni.

È importante posizionare il collettore idraulico tenendo presente le sue dimensioni e tutte le unità collegate.

Quando vengono eseguiti i fori a parete per l'installazione, assicurarsi di non danneggiare eventuali cavi elettrici o tubi esistenti.

1. Eseguire i fori e inserire le viti.
Montare il collettore con le staffe a parete mostrate. Fissare le staffe a parete e posizionare il collettore.

2. Scegliere la posizione corretta per tubi e fori per i gruppi di miscelazione utilizzando la dima di montaggio in dotazione con tali unità.

3. Collegare i gruppi di miscelazione al collettore.

1 GMA121, GMA131, GMA221, GMA231

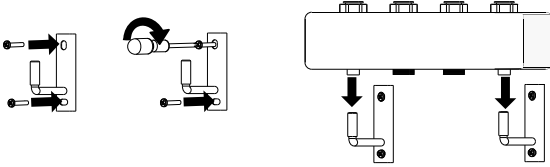

1 GMA321, GMA331

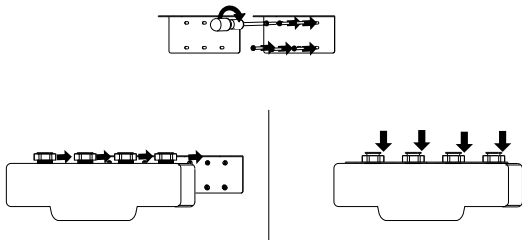

2 GMA121, GMA131, GMA221, GMA231, GMA321, GMA331

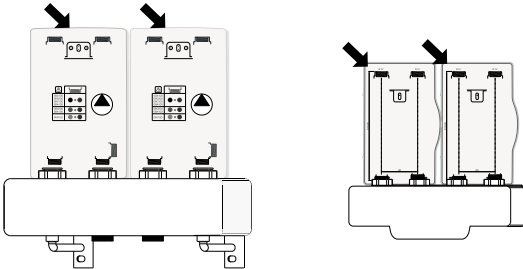

3 GMA121, GMA131, GMA221, GMA231, GMA321, GMA331

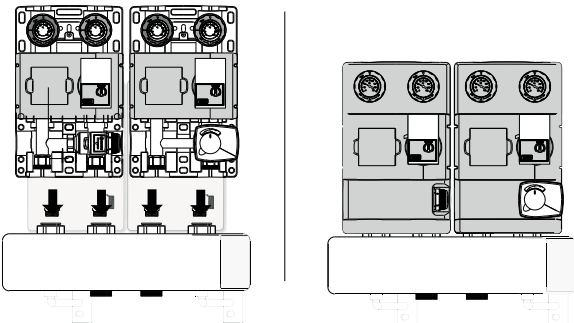

ESEMPIO D'INSTALLAZIONE

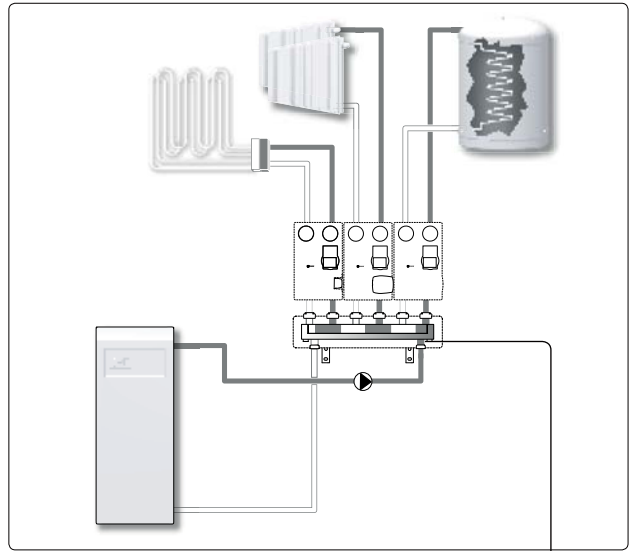

GMA121, GMA131, GMA221, GMA231

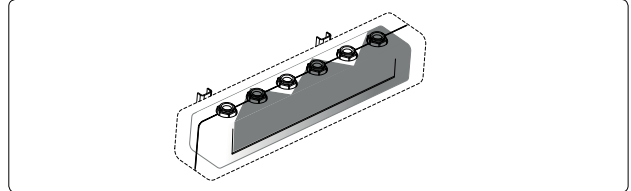

OPZIONI PER GMA221 E GMA231

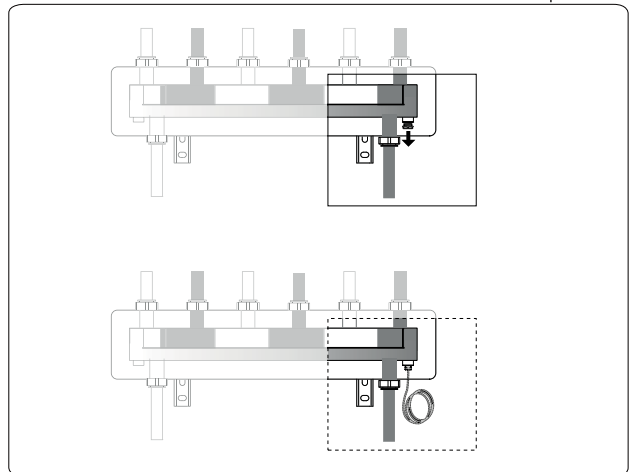

Tutti gli schemi dei tubi sono forniti a titolo indicativo.



www.esbe.eu



NO.1 IN HYDRONIC SYSTEM CONTROL



SERIES	FONCTION		
	Retour	Départ	
ESBE GMA121			Collecteur pour 2 groupes hydrauliques, sans la fonction de séparateur hydraulique intégré.
ESBE GMA131			Collecteur pour 3 groupes hydrauliques, sans la fonction de séparateur hydraulique intégré.
ESBE GMA221			Collecteur pour 2 groupes hydrauliques, avec la fonction de séparateur hydraulique intégré.
ESBE GMA231			Collecteur pour 3 groupes hydrauliques, avec la fonction de séparateur hydraulique intégré.
ESBE GMA321			Collecteur pour 2 groupes hydrauliques, sans la fonction de séparateur hydraulique intégré.
ESBE GMA331			Collecteur pour 3 groupes hydrauliques, sans la fonction de séparateur hydraulique intégré.



INSTALLATIONS MULTIPLES DE GROUPES

HYDRAULIQUES

Si plusieurs groupes hydrauliques doivent être utilisés, nous recommandons l'utilisation du collecteur de la série ESBE GMA, avec ou sans séparateur hydraulique. Si aucun ballon de stockage n'est disponible, nous préconisons l'utilisation d'un collecteur équipé d'un séparateur.

INSTALLATION MURALE

Installez l'équipement contre un mur solide qui n'est pas soumis à des vibrations. Il est important de positionner le collecteur hydraulique en tenant compte de sa taille et de tous les groupes hydrauliques qui y sont connectés.

Au moment de percer les trous dans le mur aux fins de l'installation, veillez à ne pas endommager les câbles électriques éventuels ou les canalisations existantes.

1. Percez les trous puis insérez les vis.

Installez le collecteur dans les supports muraux prévus à cet effet. Fixez les supports contre le mur et positionnez le collecteur.

2. Pour le positionnement adéquat des tuyaux, veuillez utiliser le gabarit fourni dans l'emballage des groupes hydrauliques.

3. Raccordez les groupes hydrauliques au collecteur.

1 GMA121, GMA131, GMA221, GMA231

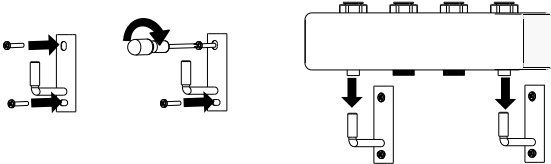

1 GMA321, GMA331

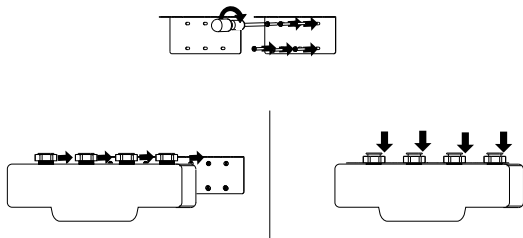

2 GMA121, GMA131, GMA221, GMA231, GMA321, GMA331

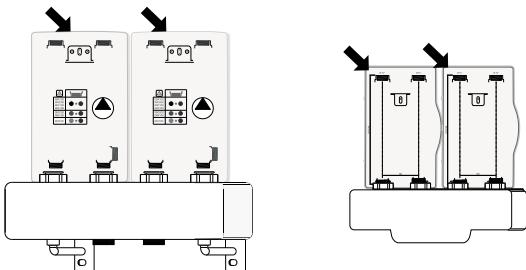

3 GMA121, GMA131, GMA221, GMA231, GMA321, GMA331

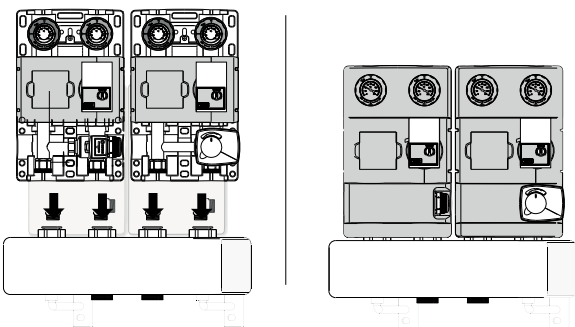

EXEMPLE D'INSTALLATION

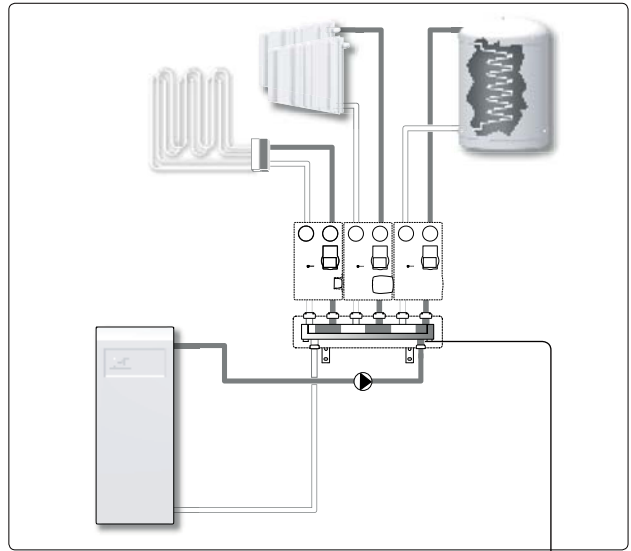

GMA121, GMA131, GMA221, GMA231

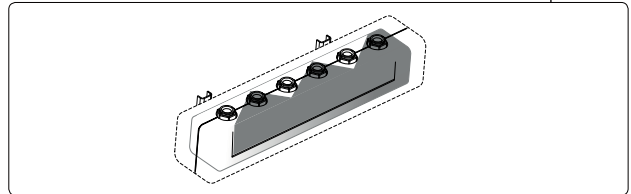

OPTIONS POUR LES COLLECTEURS GMA221 ET GMA231

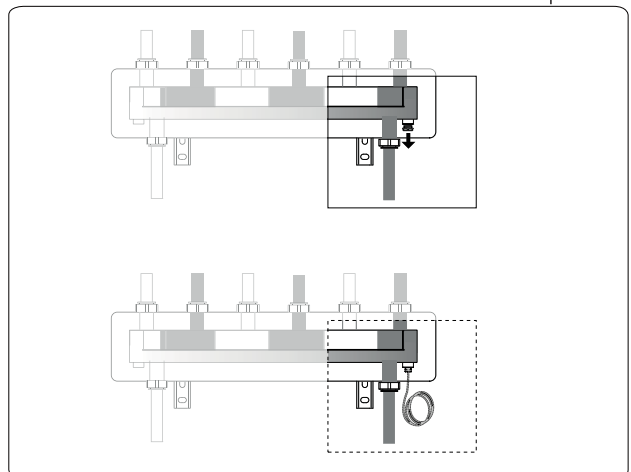

Tous les schémas de raccordement sont des représentations générales.





www.esbe.eu



NO.1 IN HYDRONIC SYSTEM CONTROL

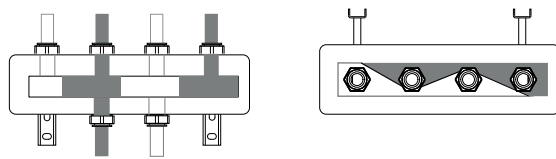
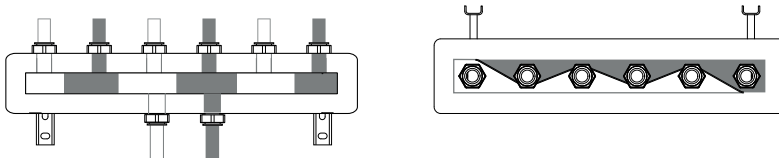
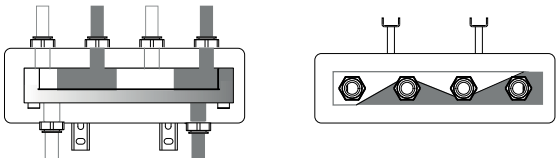
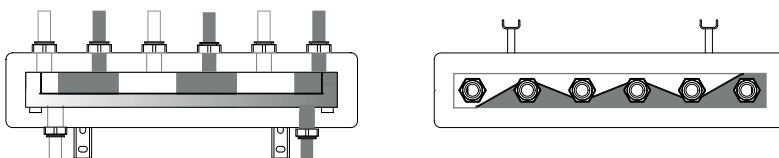

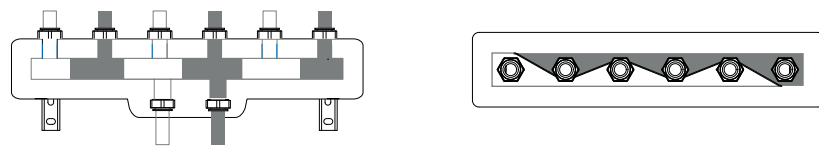
СЕРИЯ	ФУНКЦИЯ Return Supply 	
ESBE GMA121		Коллектор для 2-х насосных групп без встроенного гидравлического разделителя.
ESBE GMA131		Коллектор для 3-х насосных групп без встроенного гидравлического разделителя.
ESBE GMA221		Коллектор для 2-х насосных групп со встроенным гидравлическим разделителем.
ESBE GMA231		Коллектор для 3-х насосных групп со встроенным гидравлическим разделителем.
ESBE GMA321		Коллектор для 2-х насосных групп без встроенного гидравлического разделителя.
ESBE GMA331		Коллектор для 3-х насосных групп без встроенного гидравлического разделителя.



МОНТАЖ НЕСКОЛЬКИХ НАСОСНЫХ ГРУПП

Если необходимо установить несколько насосных групп, рекомендуется использовать коллектор серии ESBE GMA с гидравлическим сепаратором или без него.

МОНТАЖ НА СТЕНУ

Монтируйте устройство на капитальную стену, которая не подвергается воздействию вибраций. Очень важно разместить гидравлический коллектор с учетом его габаритов, а также габаритов подсоединенных групп.

При просверливании отверстий в стене для монтажа оборудования действуйте осторожно, чтобы не повредить электропроводку или существующий трубопровод.

1. Просверлите отверстия и вставьте дюбели. Монтируйте коллектор на настенные кронштейны. Прикрепите кронштейны к стене и установите коллектор.
2. Правильное расположение отверстий для насосной группы определите с помощью установочного шаблона, входящего в комплект поставки насосной группы.
3. Подсоедините насосные группы к коллектору.

1 GMA121, GMA131, GMA221, GMA231

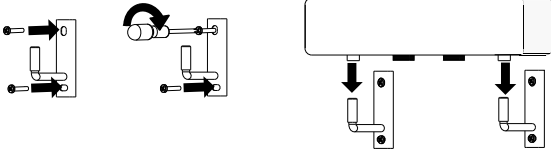

1 GMA321, GMA331

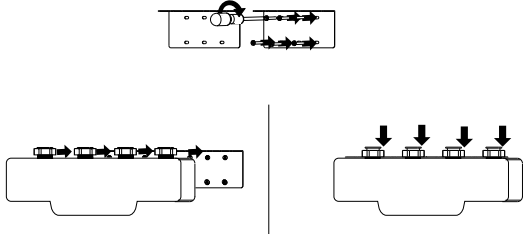

2 GMA121, GMA131, GMA221, GMA231, GMA321, GMA331

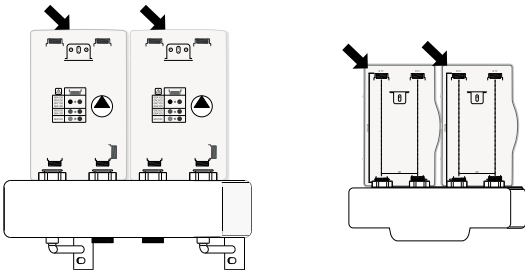

3 GMA121, GMA131, GMA221, GMA231, GMA321, GMA331

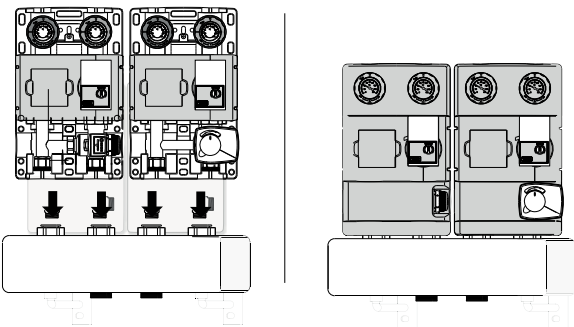

ПРИМЕР УСТАНОВКИ

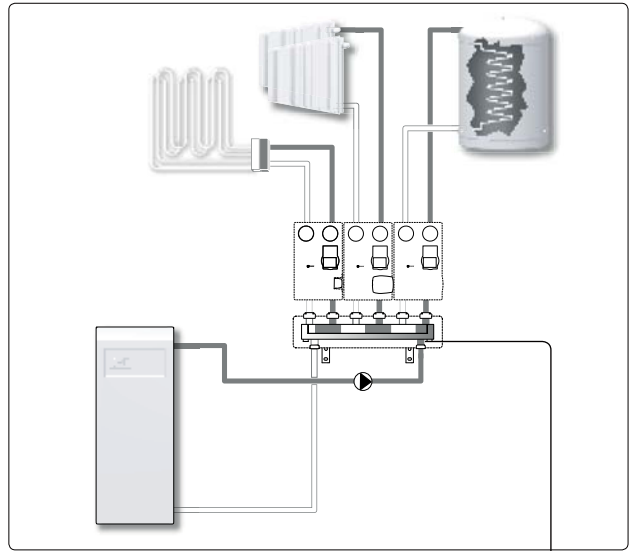

GMA121, GMA131, GMA221, GMA231

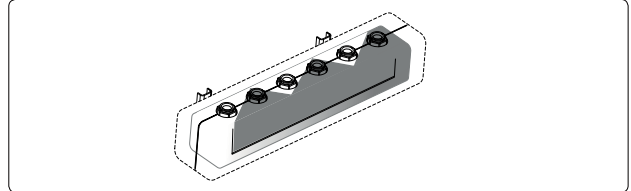

ВАРИАНТЫ ДЛЯ GMA221 И GMA231

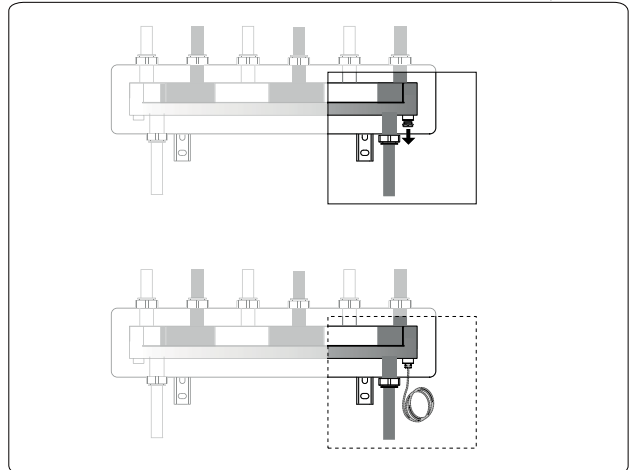

Все представленные схемы дают только общее представление.



www.esbe.eu

ESBE

NO.1 IN HYDRONIC SYSTEM CONTROL



NIMETUS	TÖÖPÕHIMÕTE	Tagasivool	Pealevool	
ESBE GMA121				Kollektor kahele ringlusmoodulile.
ESBE GMA131				Kollektor kolmele ringlusmoodulile.
ESBE GMA221				Kollektor kahele ringlusmoodulile. koos sisseehitatud hüdraulilise tasandiga.
ESBE GMA231				Kollektor kolmele ringlusmoodulile. koos sisseehitatud hüdraulilise tasandiga.
ESBE GMA321				Kollektor kahele ringlusmoodulile.
ESBE GMA331				Kollektor kolmele ringlusmoodulile.



MITME RINGLUSMOODULI ÜHENDAMINE

Kui süsteemi on vaja ühendada rohkem kui üks ringlusmoodul, on soovitatav kasutada ESBE GMA kollektorit, kas koos hüdraulilise tasandiga või ilma.

SEINAKINNITUS

Kollektori kinnitamiseks sobib tugev, vibratsioonivaba sein. Kollektori kinnitamisel tuleb arvestada nii kollektori kui ka temaga ühendatud seadmete mõõtude ning massiga.

Kinnitusavade seina puurimisel ärge kahjustage elektrijuhtmeid ja olemasolevat torustikku!

1. Puurige augud ja sisestage sobivad tüüblid. Kinnitage kaasasolevad kandurid seina külge. Kinnitage kollektor kandurite külge.
2. Kasutades kaasasolevat šablooni leidke moodulitele õige asend.
3. Kinnitage ringlusmoodul kollektori külge.

1 GMA121, GMA131, GMA221, GMA231

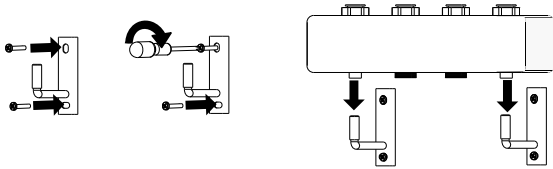

1 GMA321, GMA331

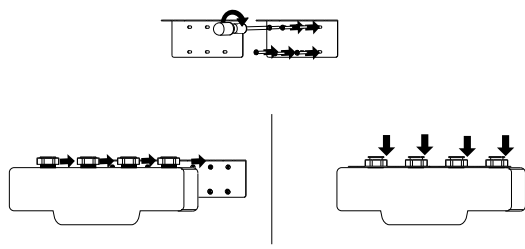

2 GMA121, GMA131, GMA221, GMA231, GMA321, GMA331

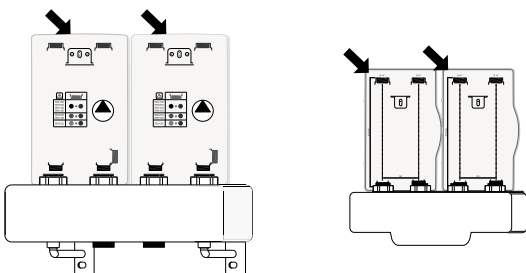

3 GMA121, GMA131, GMA221, GMA231, GMA321, GMA331

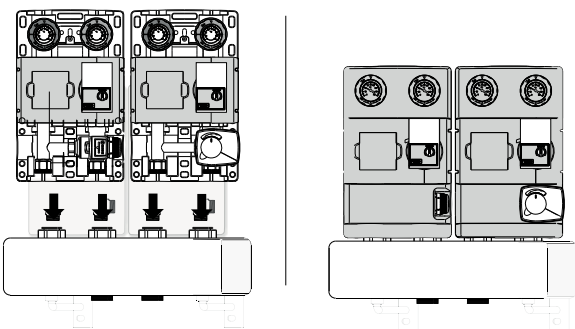

PAIGALDAMISE NÄIDIS

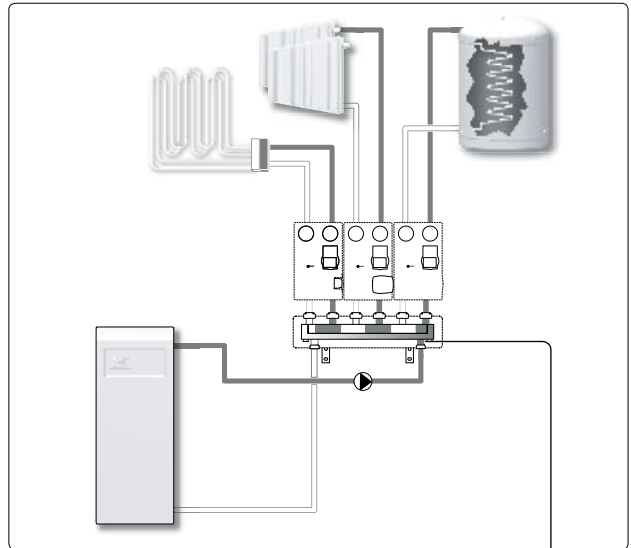

GMA121, GMA131, GMA221, GMA231

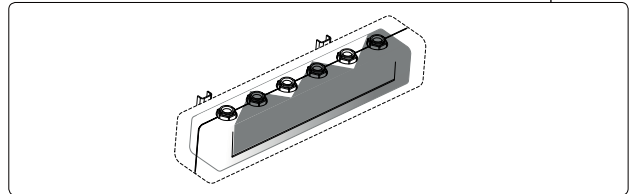

GMA221 JA GMA231 LISAD

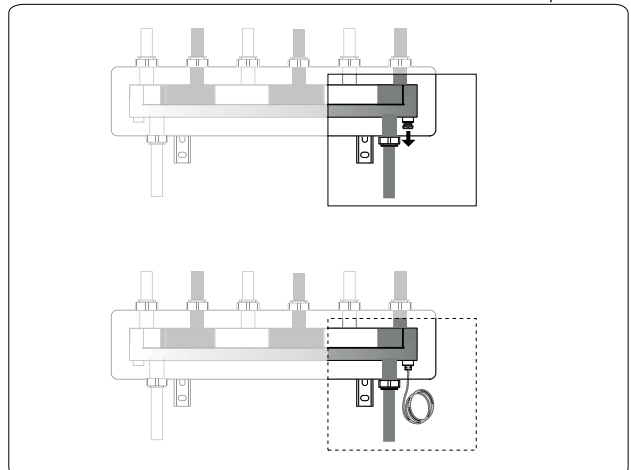

Kõik kujutatud variandid on skemaatilised.



www.esbe.eu



NO.1 IN HYDRONIC SYSTEM CONTROL

ESBE GREITO MONTAVIMO MAZGAI. PRIEDAI

KOLEKTORIUS



SERIJA	VEIKIMAS	Grįžtantis srautas	Tiekiamas srautas	
ESBE GMA121				Kolektorius dviems cirkuliaciniams mazgams be hidraulinio skirtuko.
ESBE GMA131				Kolektorius trims cirkuliaciniams mazgams be hidraulinio skirtuko.
ESBE GMA221				Kolektorius dviems cirkuliaciniams mazgams su hidraulinio skirtuku.
ESBE GMA231				Kolektorius trims cirkuliaciniams mazgams su hidraulinio skirtuku.

ESBE GMA321				Kolektorius dviems cirkuliaciniams mazgams be hidraulinio skirtuko.
ESBE GMA331				Kolektorius trims cirkuliaciniams mazgams be hidraulinio skirtuko.



KELIŲ CIRKULIACINIŲ MAZGŲ MONTAVIMAS

Jei reikia sumontuoti daugiau negu vieną cirkuliacinį mazgą, rekomenduojama naudoti ESBE GMA serijos kolektorius, kuris gali būti ir su hidrauliniu skirtuku, ir be jo.

TVIRTINIMAS PRIE SIENOS

Pritvirtinkite prietaisą prie tvirtos ir atsparios vibracijai sienos. Montuojant svarbu įvertinti kolektorius ir vėliau jungiamų mazgų dydžius.

Gręždami skylės būkite atsargūs ir nepažeiskite elektros laidų ar sienoje esančių vamzdžių.

1. Išgręžkite skylės ir įstatykite kaiščius. Kronšteinus su kolektoriais pritvirtinkite prie sienos.

2. Pagal į komplektą įeinantį montavimo šabloną parinkite tinkamą cirkuliacinių mazgų padėtį vamzdžių prijungimui.

3. Prijunkite cirkuliacinius mazgus prie kolektoriaus.

1 GMA121, GMA131, GMA221, GMA231

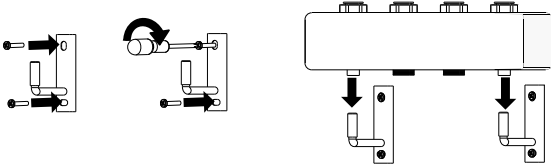

1 GMA321, GMA331

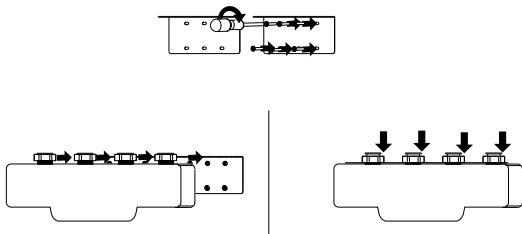

2 GMA121, GMA131, GMA221, GMA231, GMA321, GMA331

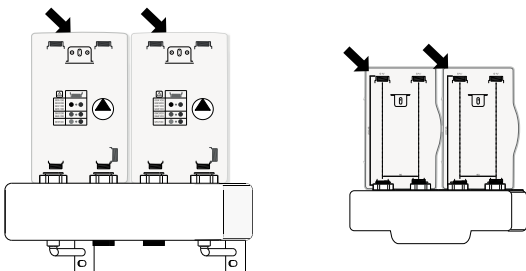

3 GMA121, GMA131, GMA221, GMA231, GMA321, GMA331

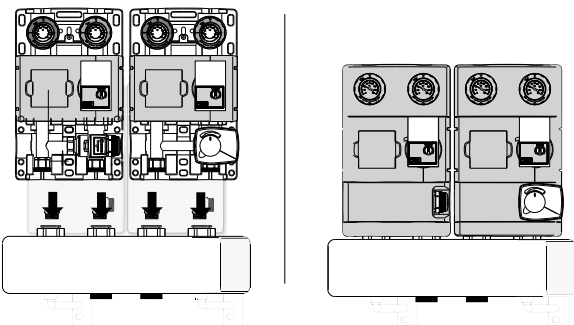

MONTAVIMO PAVYZDYS

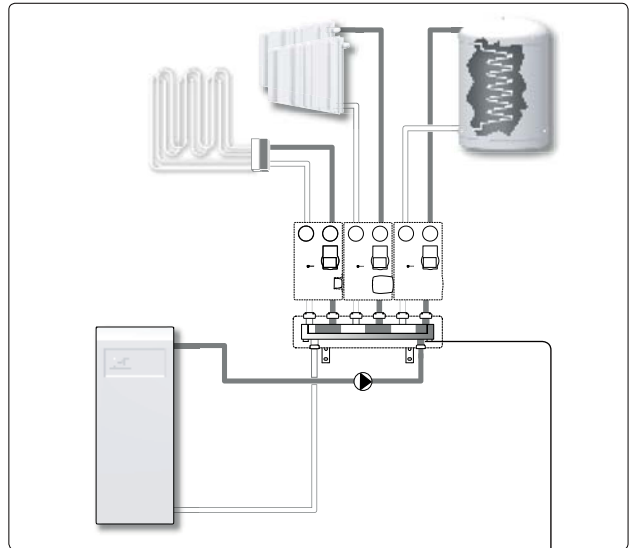

GMA121, GMA131, GMA221, GMA231

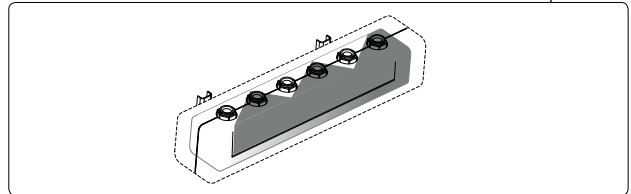

GMA221 IR GMA231 PAPILDOMOS FUNKCIJOS

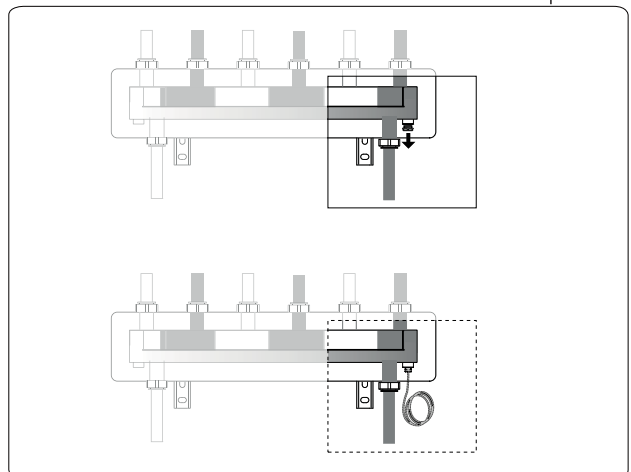

Tai - tik principinės schemas.





www.esbe.eu



NO.1 IN HYDRONIC SYSTEM CONTROL

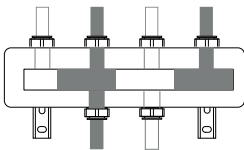
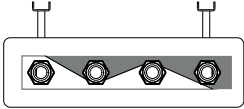
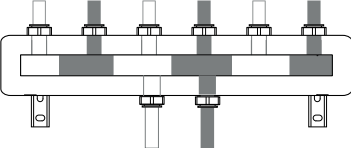
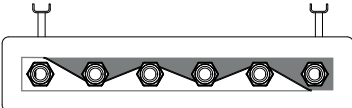
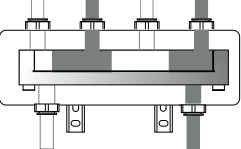
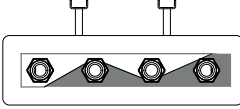
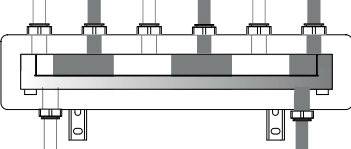
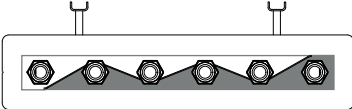
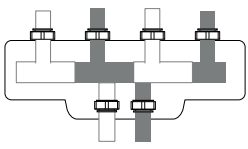
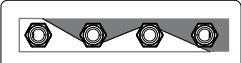
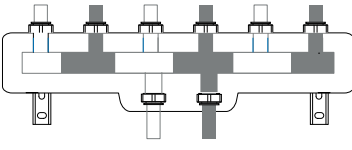
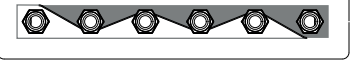

SĒRIJA	DARBĪBAS FUNKCIJAS		Atpakalgaita	Turpgaita	
					
ESBE GMA121	 				Kolektors paredzēts 2 cirkulācijas grupām, bez hidrauliskā atdalītāja funkcijas.
ESBE GMA131	 				Kolektors 3 cirkulācijas grupām, bez hidrauliskā atdalītāja funkcijas.
ESBE GMA221	 				Kolektors 2 cirkulācijas grupām, ar iebūvētu hidraulisko atdalītāju.
ESBE GMA231	 				Kolektors 3 cirkulācijas grupām, ar iebūvētu hidraulisko atdalītāju.
ESBE GMA321	 				Kolektors paredzēts 2 cirkulācijas grupām, bez hidrauliskā atdalītāja funkcijas.
ESBE GMA331	 				Kolektors 3 cirkulācijas grupām, bez hidrauliskā atdalītāja funkcijas.



VAIRĀKU CIRKULĀCIJAS GRUPU UZSTĀDĪŠANA

Ja nepieciešams uzstādīt vairāk nekā vienu cirkulācijas grupu, mēs iesakām lietot ESBE GMA sērijas kolektoros ar vai bez hidrauliskās atdalīšanas funkciju.

UZSTĀDĪŠANA UZ SIENAS

Uzstādiet kolektoru uz stabilas sienas, kurai nav iespējamas vibrācijas. Izvēlieties uzstādīšanas vietu, ir jāņem vērā kolektora izmēri un visu pievienojamo ierīču izmēri.

Urbjot caurumus sienā uzstādīšanas vajadzībām, uzmanieties, lai netiktu bojāta esošā elektroinstalācija un caurulvadi.

1. Izurbiet caurumus un ievietojiet atbilstoša materiāla dībeļus.

Nostipriniet komplektā ietilpstošos kolektora turētājus pie sienas un uzstādiet kolektoru.

2. Izvēlieties pareizu cirkulācijas grupas izvietošanu, izmantojot cirkulācijas grupas komplektācijā ietilpstošo uzstādīšanas trafaretu.

3. Pievienojiet cirkulācijas grupu pie kolektora.

1 GMA121, GMA131, GMA221, GMA231

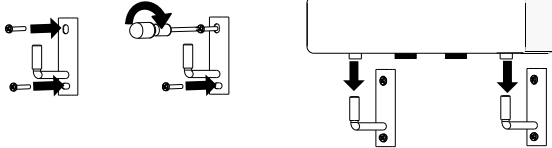

1 GMA321, GMA331

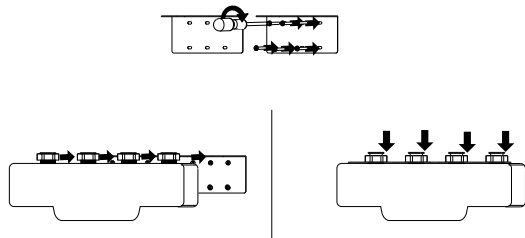

2 GMA121, GMA131, GMA221, GMA231, GMA321, GMA331

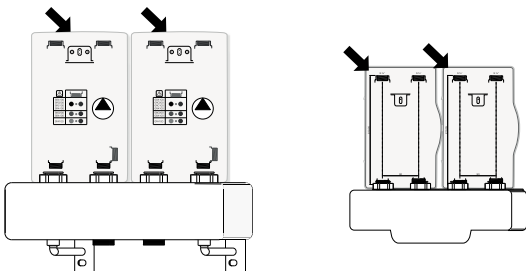

3 GMA121, GMA131, GMA221, GMA231, GMA321, GMA331

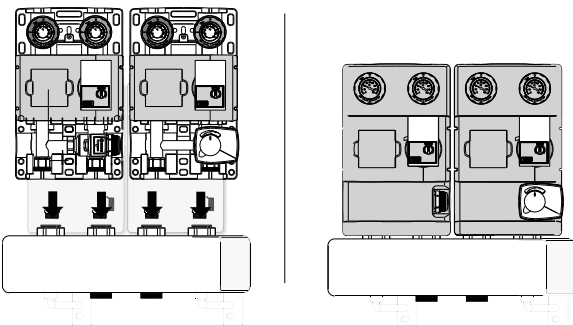

UZSTĀDĪŠANAS PIEMĒRS

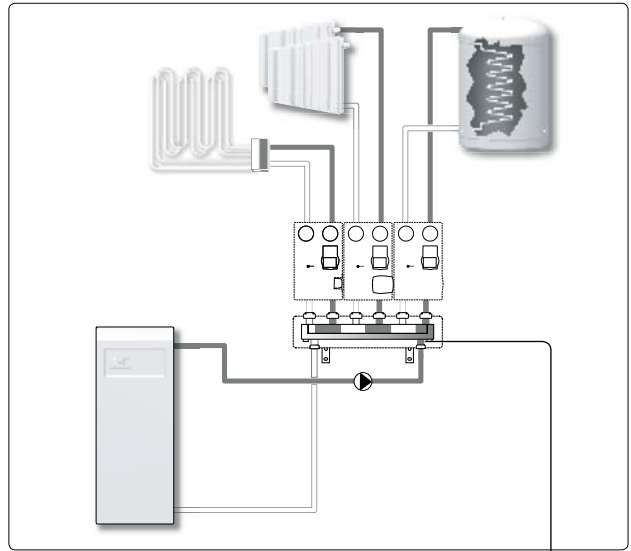

GMA121, GMA131, GMA221, GMA231

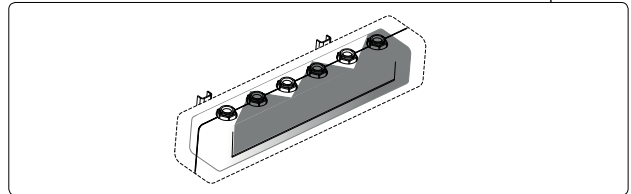

GMA221 UN GMA231 VARIANTI

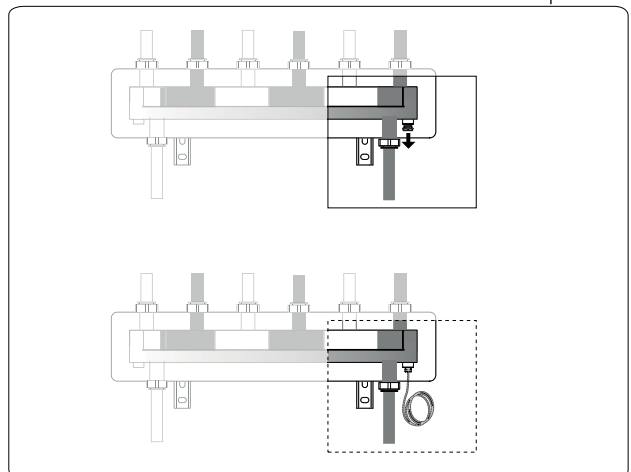

Visi caurulvadu pievienojumi ir tikai shematiski un vispārīgai informācijai.



www.esbe.eu



NO.1 IN HYDRONIC SYSTEM CONTROL

JEDNOTKY SYSTÉMU ESBE - PŘÍSLUŠENSTVÍ

ROZDĚLOVACÍ ČLEN



ŘADA	FUNKCE		
	Zpátečka	Přívod	
ESBE GMA121			Rozdělovací člen pro 2 oběhové jednotky, bez funkce integrovaného hydraulického separátoru.
ESBE GMA131			Rozdělovací člen pro 3 oběhové jednotky, bez funkce integrovaného hydraulického separátoru.
ESBE GMA221			Rozdělovací člen pro 2 oběhové jednotky, s funkcí integrovaného hydraulického separátoru.
ESBE GMA231			Rozdělovací člen pro 3 oběhové jednotky, s funkcí integrovaného hydraulického separátoru.
ESBE GMA321			Rozdělovací člen pro 2 oběhové jednotky, bez funkce integrovaného hydraulického separátoru.
ESBE GMA331			Rozdělovací člen pro 3 oběhové jednotky, bez funkce integrovaného hydraulického separátoru.



INSTALACE VÍCE OBĚHOVÝCH JEDNOTEK

Pokud je třeba použít více oběhových jednotek, doporučujeme použít rozdělovací člen ESBE řady GMA s hydraulickým separátorem nebo bez separátoru.

INSTALACE NA STĚNU

Nainstalujte zařízení na pevnou stěnu, která není vystavena vibracím. Při umísťování hydraulického rozdělovacího členu je důležité vzít v úvahu jeho velikost a všechny připojené jednotky.

Při vrtání otvorů do stěny za účelem instalace dávejte pozor, abyste nepoškodili žádné elektrické vedení nebo stávající potrubí.

1. Vyrvejte otvory a vložte do nich vhodné hmoždinky. Namontujte rozdělovací člen s dodanými nástěnnými držáky. Připevněte držáky na stěnu a umístěte na ně rozdělovací člen.
2. Pomocí dodané montážní šablony, která je součástí balení oběhových jednotek, zvolte správnou polohu pro potrubí a oběhové jednotky.
3. Připojte oběhové jednotky k rozdělovacímu členu.

1 GMA121, GMA131, GMA221, GMA231

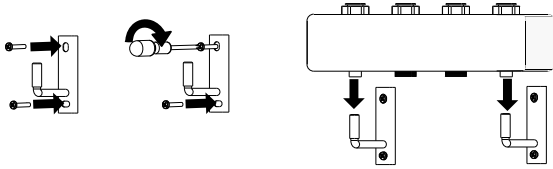

1 GMA321, GMA331

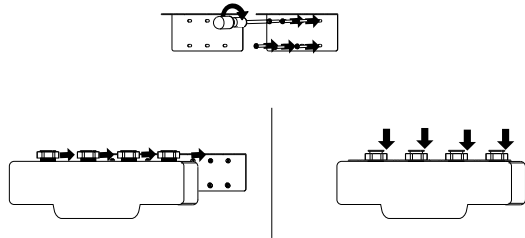

2 GMA121, GMA131, GMA221, GMA231, GMA321, GMA331

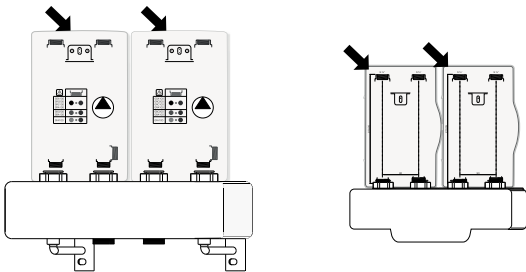

3 GMA121, GMA131, GMA221, GMA231, GMA321, GMA331

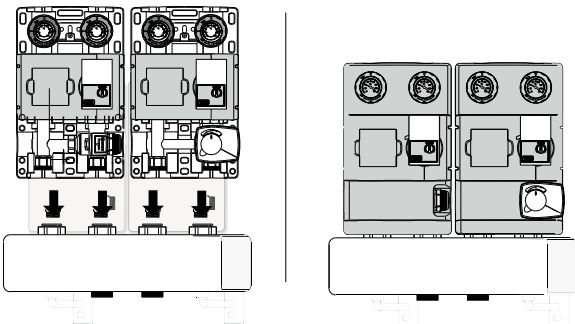

PŘÍKLAD INSTALACE

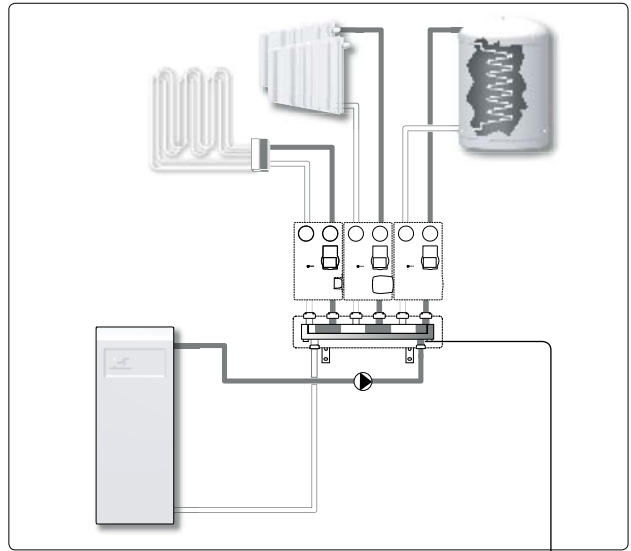

GMA121, GMA131, GMA221, GMA231

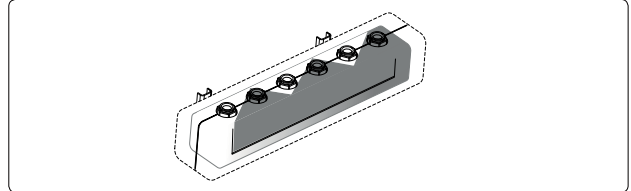

MOŽNOSTI PRO GMA221 A GMA231

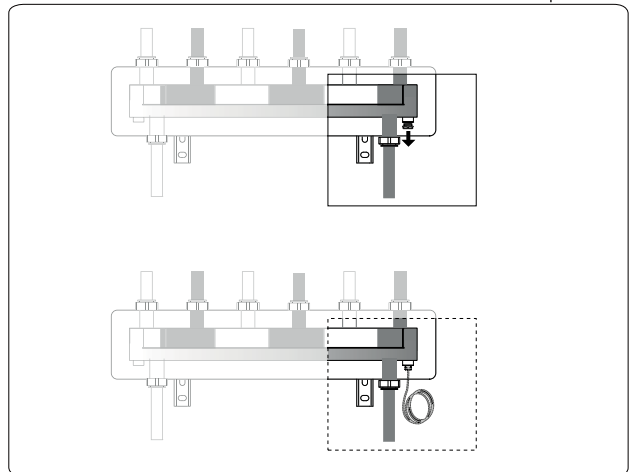

Všechna schémata potrubí jsou pouze všeobecná vyobrazení.





www.esbe.eu



NO.1 IN HYDRONIC SYSTEM CONTROL

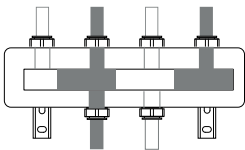
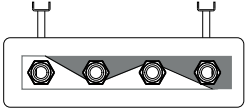
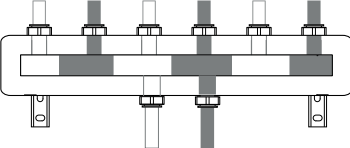
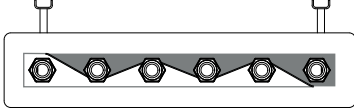
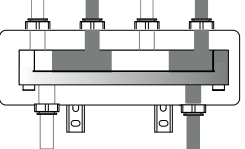
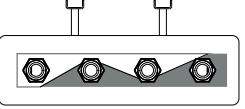
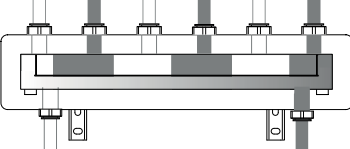
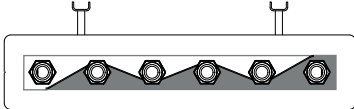
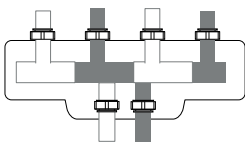
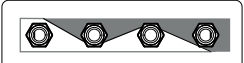
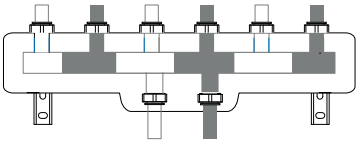
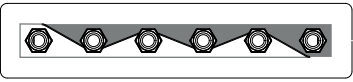

SERIJA	<p>LEGENDA</p> <div style="display: flex; justify-content: space-around; align-items: center;"> <div style="text-align: center;"> <p>Povratni vod</p>  </div> <div style="text-align: center;"> <p>Dvižni vod</p>  </div> </div>
ESBE GMA121	<div style="display: flex; justify-content: space-around; align-items: center;">   </div> <p>Razdelilec za 2 veji, brez hidravlične kretnice</p>
ESBE GMA131	<div style="display: flex; justify-content: space-around; align-items: center;">   </div> <p>Razdelilec za 3 veje, brez hidravlične kretnice</p>
ESBE GMA221	<div style="display: flex; justify-content: space-around; align-items: center;">   </div> <p>Razdelilec za 2 veji, z vgrajeno hidravlično kretnico</p>
ESBE GMA231	<div style="display: flex; justify-content: space-around; align-items: center;">   </div> <p>Razdelilec za 2 veji, z vgrajeno hidravlično kretnico</p>
ESBE GMA321	<div style="display: flex; justify-content: space-around; align-items: center;">   </div> <p>Razdelilec za 2 veji, brez hidravlične kretnice</p>
ESBE GMA331	<div style="display: flex; justify-content: space-around; align-items: center;">   </div> <p>Razdelilec za 3 veje, brez hidravlične kretnice</p>



VGRADNJA ČRPALČNIH SKLOPOV

V primeru vgradnje dveh ali več sklopov priporočamo uporabo ESBE GMA razdelilca, z ali brez vgrajene hidravlične kretnice.

STENSKA VGRADNJA

Pazite da bo nosilni zid čvrst in brez vibracij. Pred vgradnjo preverite vse vgradne dimenzije sklopov in razdelilca.

Pred vrtnanjem preverite da vam niso v napoto elektro ali drugi inštalacijski vodi.

1. Izvrтайте ustrezne luknje in vložite ustrezne vložke. Montirajte priložene nosilce, nato še razdelilec.
2. S pomočjo priložene šablone označite ustrezen položaj dvizhnih in povratnih vodov.
3. Privijte črpalčne sklope na razdelilec.

1 GMA121, GMA131, GMA221, GMA231

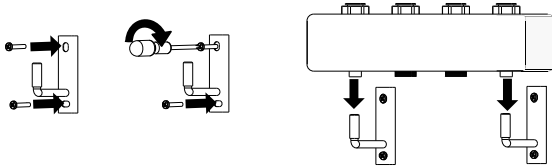

1 GMA321, GMA331

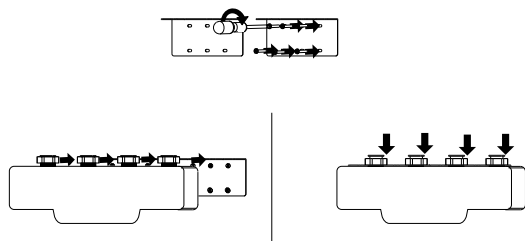

2 GMA121, GMA131, GMA221, GMA231, GMA321, GMA331

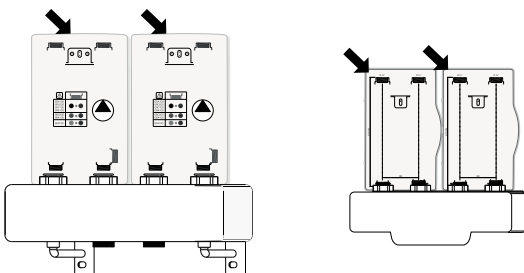

3 GMA121, GMA131, GMA221, GMA231, GMA321, GMA331

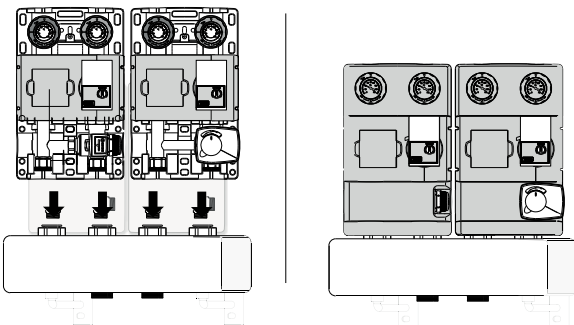

PRIMER VGRADNJE

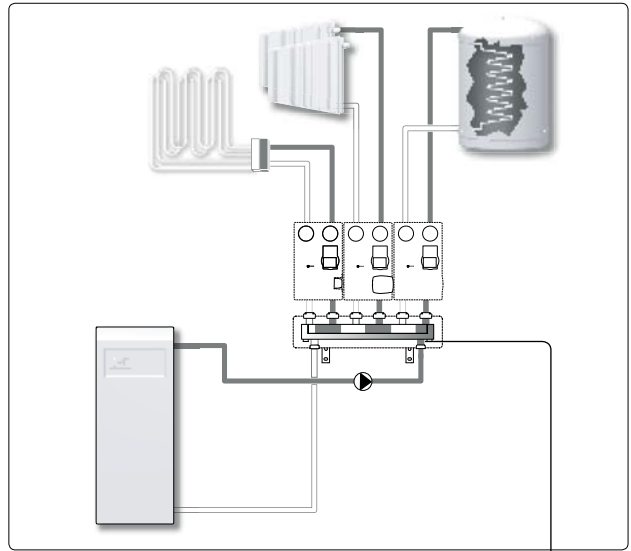

GMA121, GMA131, GMA221, GMA231

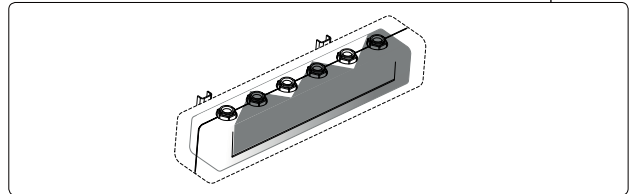

DODATEK ZA GMA221 IN GMA231

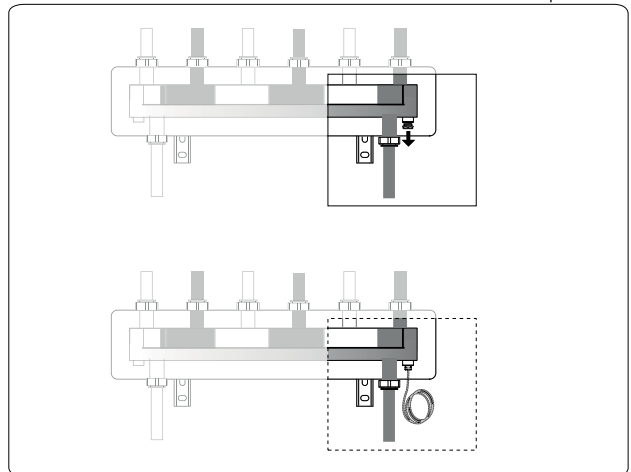

Prikazana je neobvezujoča shema.



www.esbe.eu

ESBE

NO.1 IN HYDRONIC SYSTEM CONTROL



SARJA	TOIMINTA		
	Paluu	Syöttö	
ESBE GMA121			Jakotukki kahdelle pumppuryhmälle, ilman integroitua hydraulista erottelutoimintoa.
ESBE GMA131			Jakotukki kolmelle pumppuryhmälle, ilman integroitua hydraulista erottelutoimintoa.
ESBE GMA221			Jakotukki kahdelle pumppuryhmälle, varustettu integroidulla hydraulisella erottelutoiminnolla.
ESBE GMA231			Jakotukki kolmelle pumppuryhmälle, varustettu integroidulla hydraulisella erottelutoiminnolla.
ESBE GMA321			Jakotukki kahdelle pumppuryhmälle, ilman integroitua hydraulista erottelutoimintoa.
ESBE GMA331			Jakotukki kolmelle pumppuryhmälle, ilman integroitua hydraulista erottelutoimintoa.



1 USEAN PUMPPURYHMÄN ASENTAMINEN

Jos on käytettävä useita pumppuryhmiä, suosittelemme ESBE:n GMA-sarjan jakotukkia joko hydraulisella erottimella varustettuna tai ilman sitä.

SEINÄASENNUS

Asenna laite kiinteään seinään, joka ei ole alttiina värinälle. Jakotukin sijoittamisessa on huomioitava sen koko ja kaikki siihen kytkettävät ryhmät.

Asennusreiäiä seinään porattaessa on varottava olemassa olevia sähköjohtotuksia ja putkistoja.

1. Poraa reiät ja aseta tarkoitukseen sopivat kiinnitystulpat paikoilleen. Kiinnitä jakotukki laitteen mukana toimitetuilla seinäkannattimilla. Kiinnitä kannattimet seinään ja aseta jakotukki paikalleen.

2. Valitse pumppuryhmän putkiston asennuspaikka käyttämällä apuna pumppuryhmän pakkauksessa toimitettua kiinnitysmallia.

3. Liitä pumppuryhmät jakotukkiin.

1 GMA121, GMA131, GMA221, GMA231

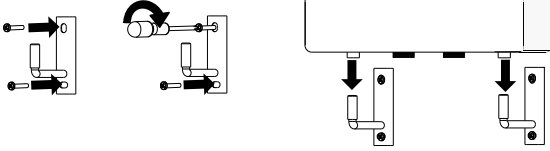

1 GMA321, GMA331

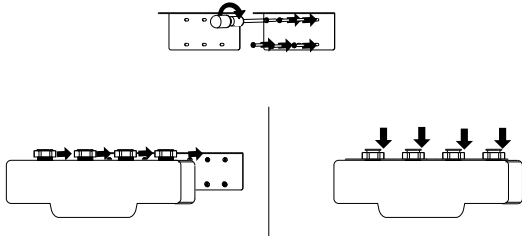

2 GMA121, GMA131, GMA221, GMA231, GMA321, GMA331

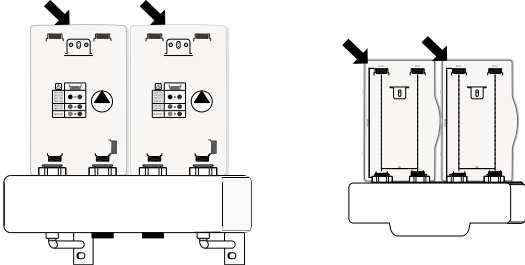

3 GMA121, GMA131, GMA221, GMA231, GMA321, GMA331

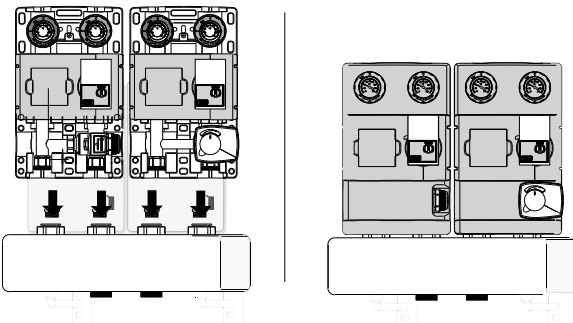

ASENNUSESIMERKKI

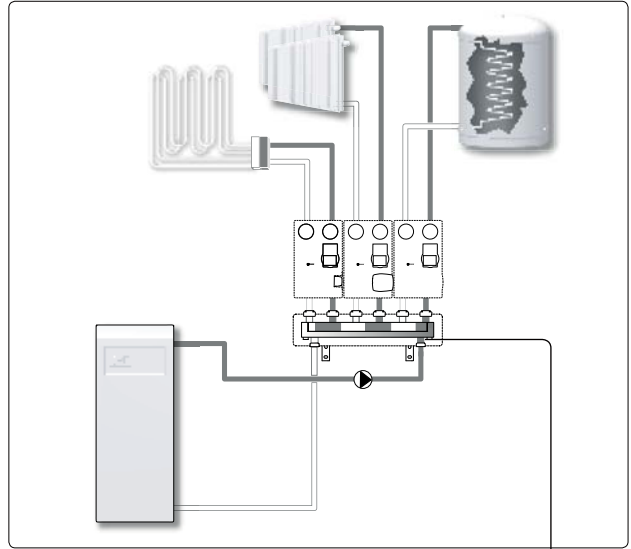

GMA121, GMA131, GMA221, GMA231

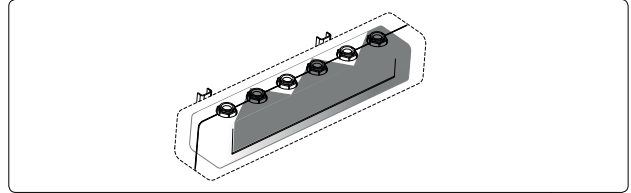

JAKOTUKKIEN GMA221 JA GMA231 LISÄVARUSTEET

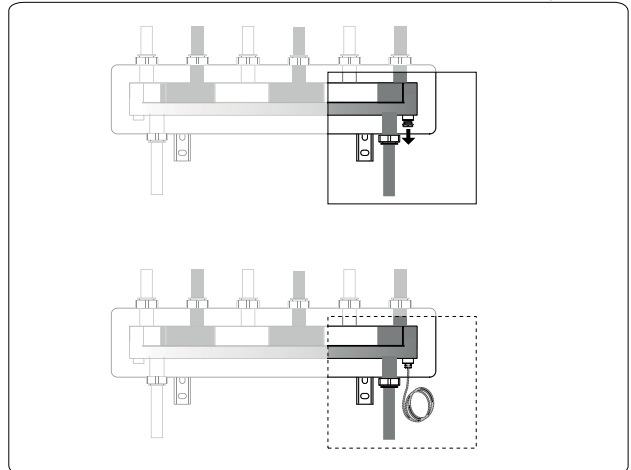

Kaikki putkikaaviot ovat yleisiä esimerkkejä.



www.esbe.eu



NO.1 IN HYDRONIC SYSTEM CONTROL



www.esbe.eu



NO.1 IN HYDRONIC SYSTEM CONTROL

Mtrl.nr: 98140491 • Ritn.nr: 7396 utg. D • Rev. 1706