



SERIES VRG230

ESBE
NO.1 IN HYDRONIC SYSTEM CONTROL

Mtrl.nr: 9814 02 72 • Ritn.nr: 7048 utg C • Rev. 1605



Series VRG231
Series VRG232
Series VRG233
Series VRG238

CE
PED 2014/68/EU, article 4.3

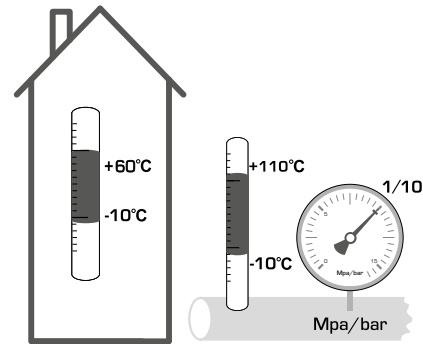

1

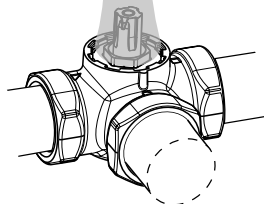
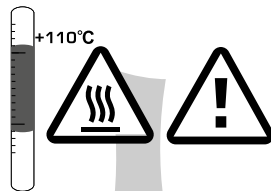
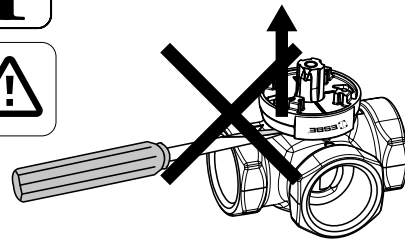
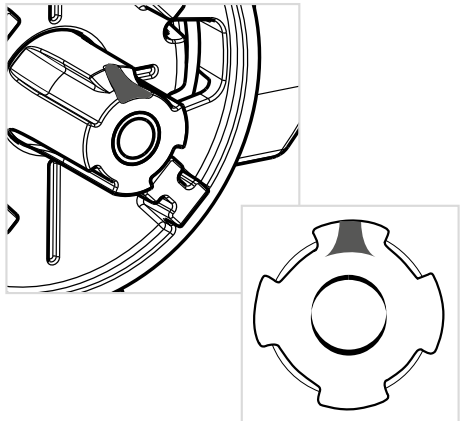
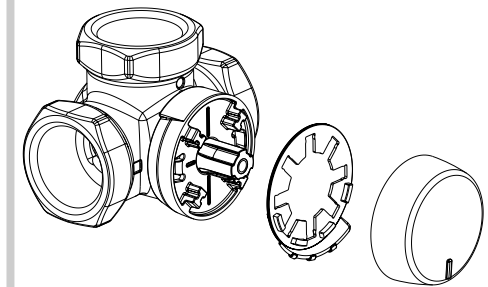

Piping Schematics are General Representations

2

a

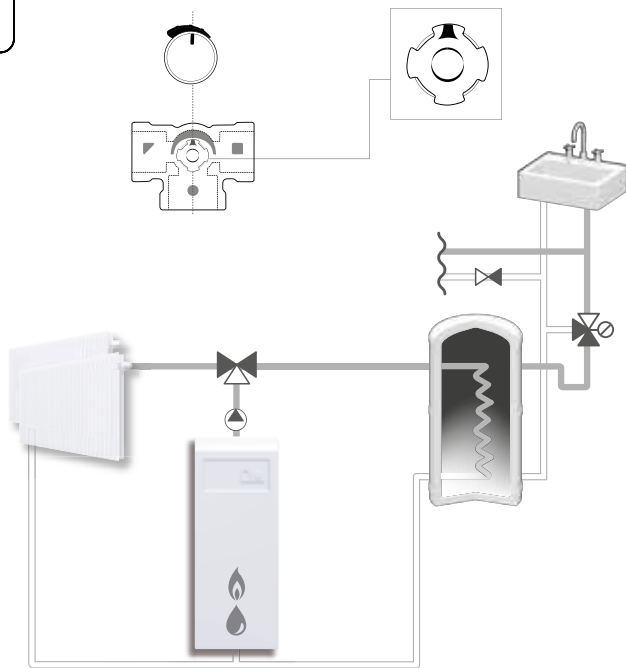

b

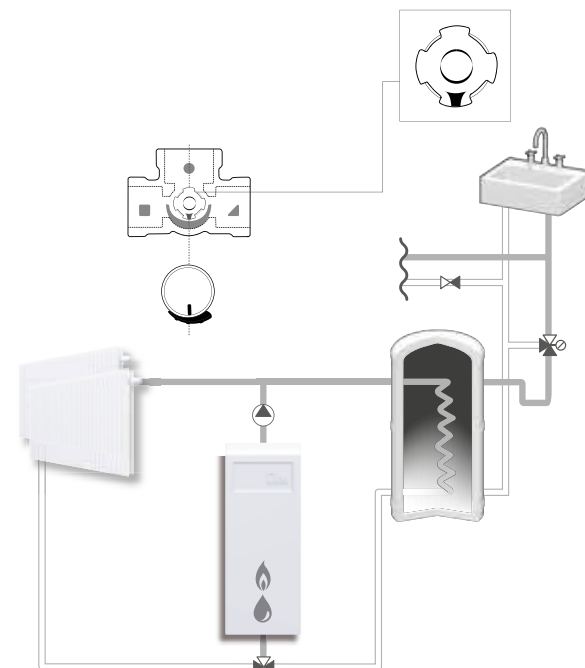

i



<http://www.esbe.eu/global/en/products/rotary-valves>