



**SERIES VRG140**



Mtrl.nr: 9814 02 70 • Ritn.nr: 7046 utg. C • Rev. 1605



Series VRG141  
Series VRG142  
Series VRG143  
CE

PED 2014/68/EU, article 4.3

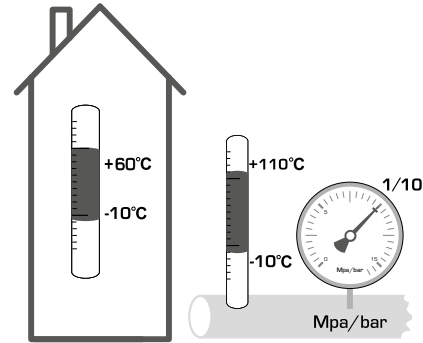

**1**

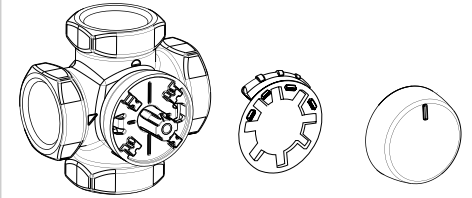

**i**

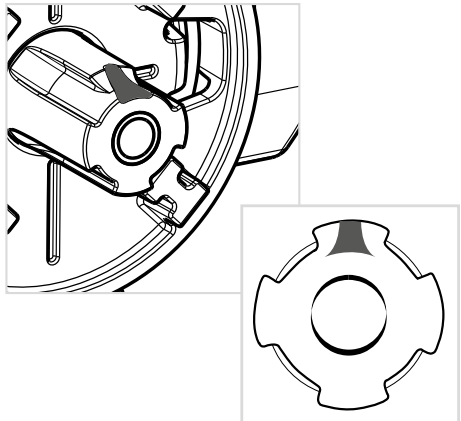

**i**

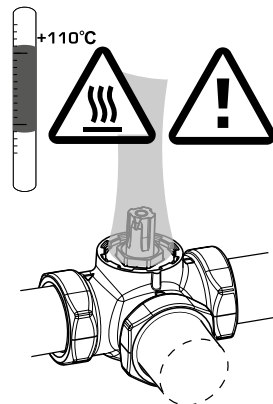
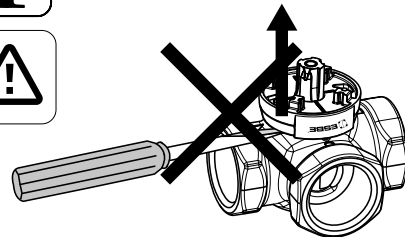

**2**

**a**

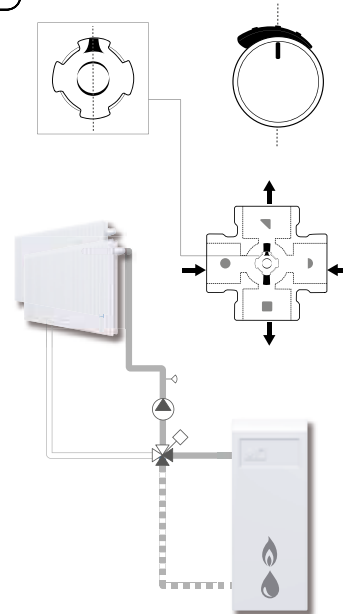

**b**

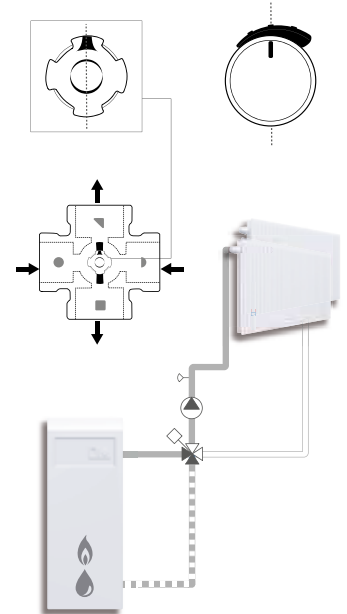

Piping Schematics are General Representations



[http://www.esbe.eu/global/en/  
products/rotary-valves](http://www.esbe.eu/global/en/products/rotary-valves)