

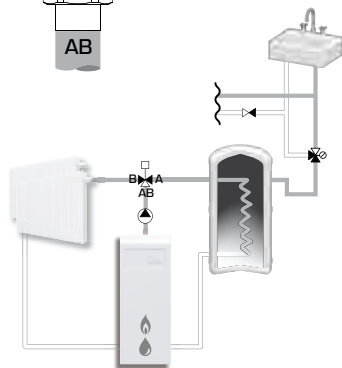

Serie MBA 13x

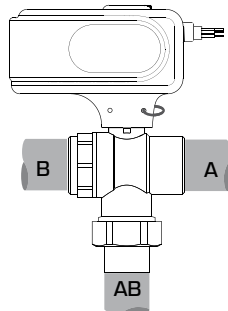

Piping Schematics are General Representations



Mtrl.nr. 98140881 • Ritn.nr 9252 utg B • Rev 1412 Printed in EU



SERIES MBA100



NO.1 IN HYDRONIC SYSTEM CONTROL



Series MBA 12x
Series MBA 13x

CE
LVD 2006/95/EC
EMC 2004/108/EC
RoHS 2011/65/EC

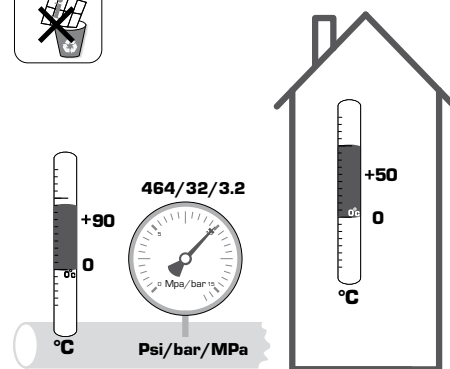

1 **IP44 POSITION**

RECOMMENDED

NOT GUARANTEED

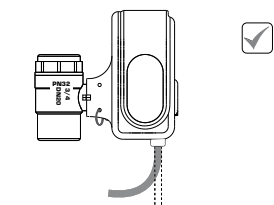
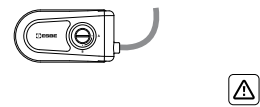
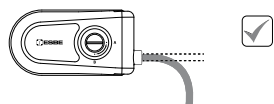
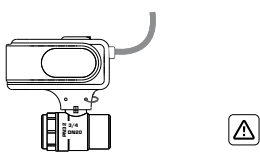
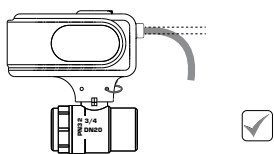

NOT ALLOWED

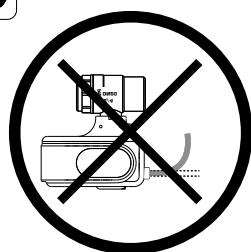

2A **Serie MBA 12x**

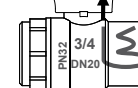
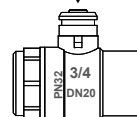
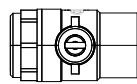
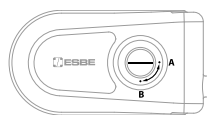

2B **Serie MBA 13x**

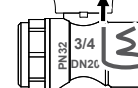
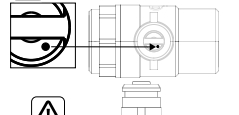
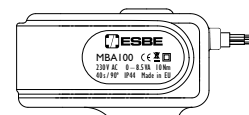
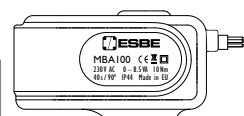
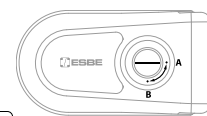

3A

Serie MBA 12x

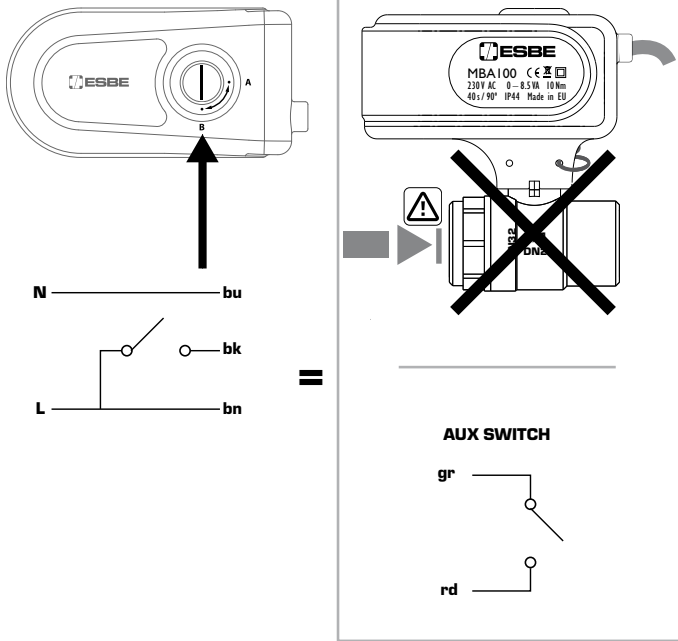

3B

Serie MBA 12x

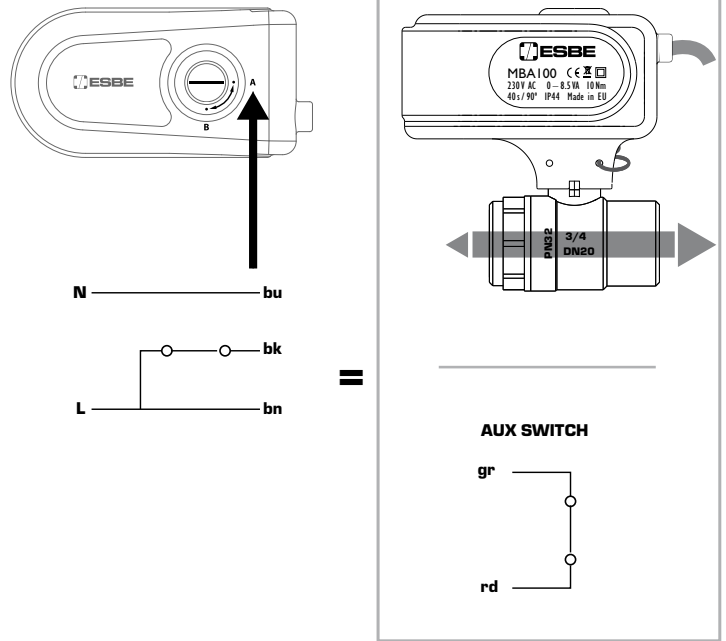

4A

Serie MBA 13x

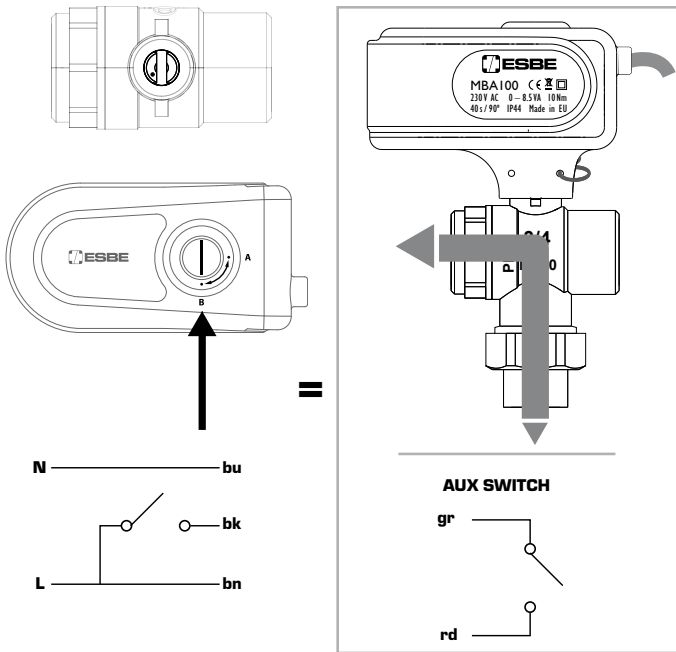

4B

Serie MBA 13x

