



SERIES VLB325/VLB335



Series VLB325
Series VLB335



PED 2014/68/EU, article 4.3

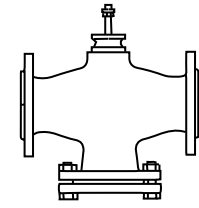
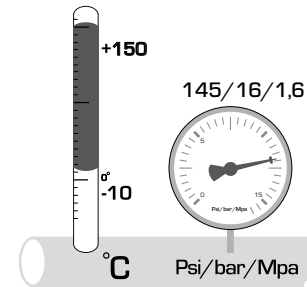

Series VLB325

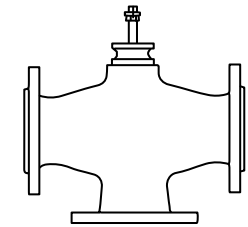

Series VLB335

Mtrl.nr: 9814 09 21 • Ritn.nr: 6286 utg. B • Rev. 1608

1

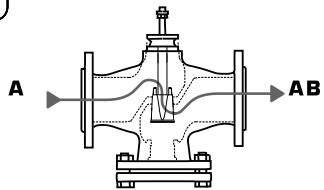

VLB325

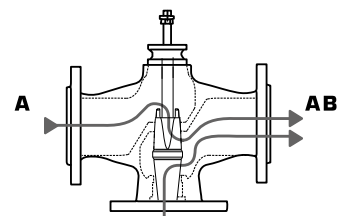

VLB335

2

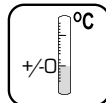

1/2/3/4/5/6/7/8 = 50%
9/10/11/12/13/14/15/16 = 100%

M

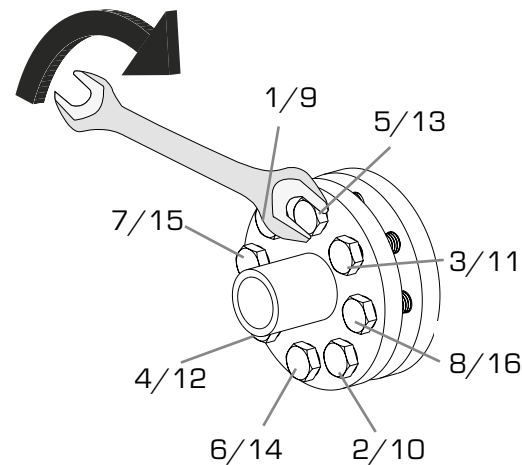

3

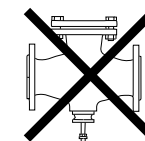
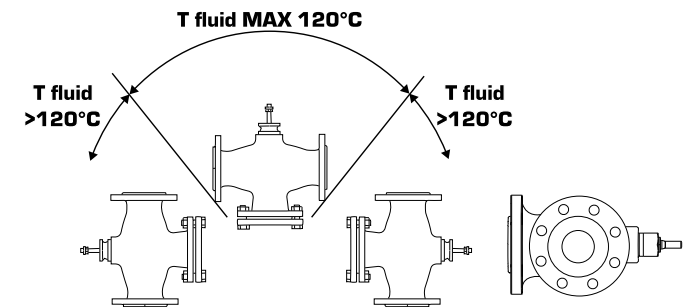

4

VLB325

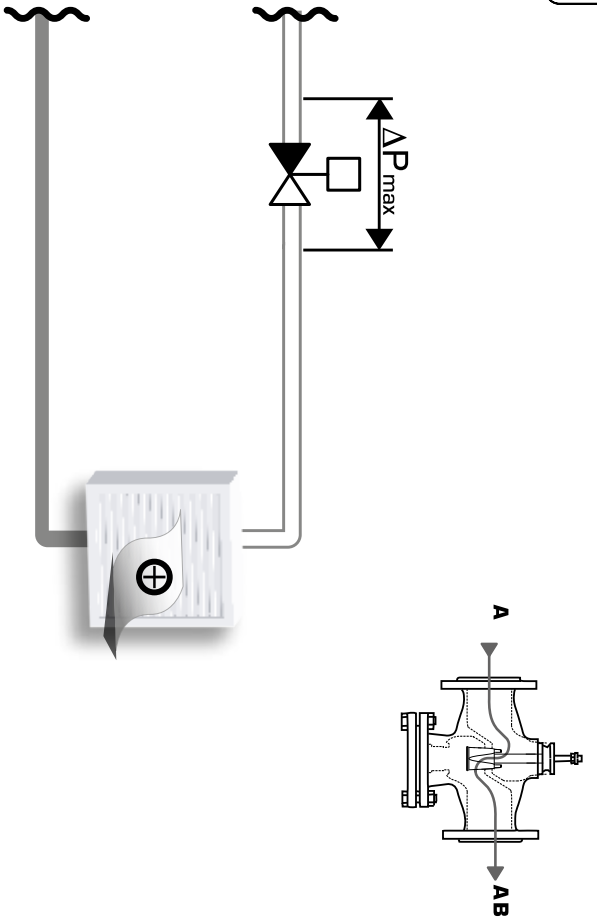
**6**

VLB335

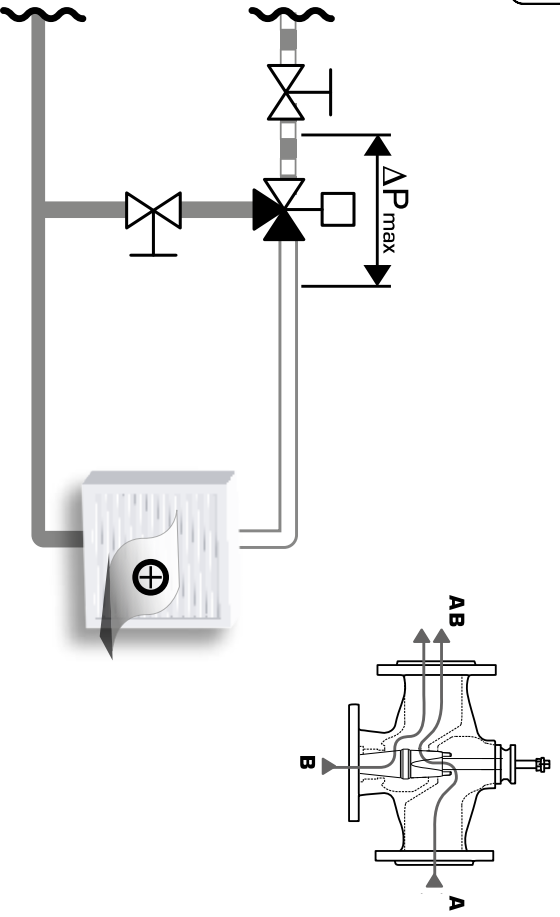
**5**

VLB325

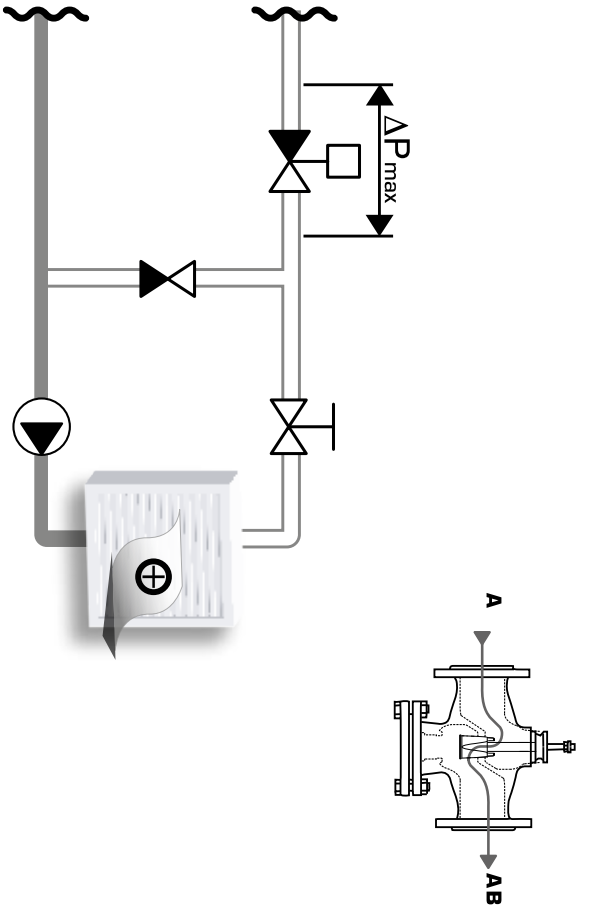
**7**

VLB335

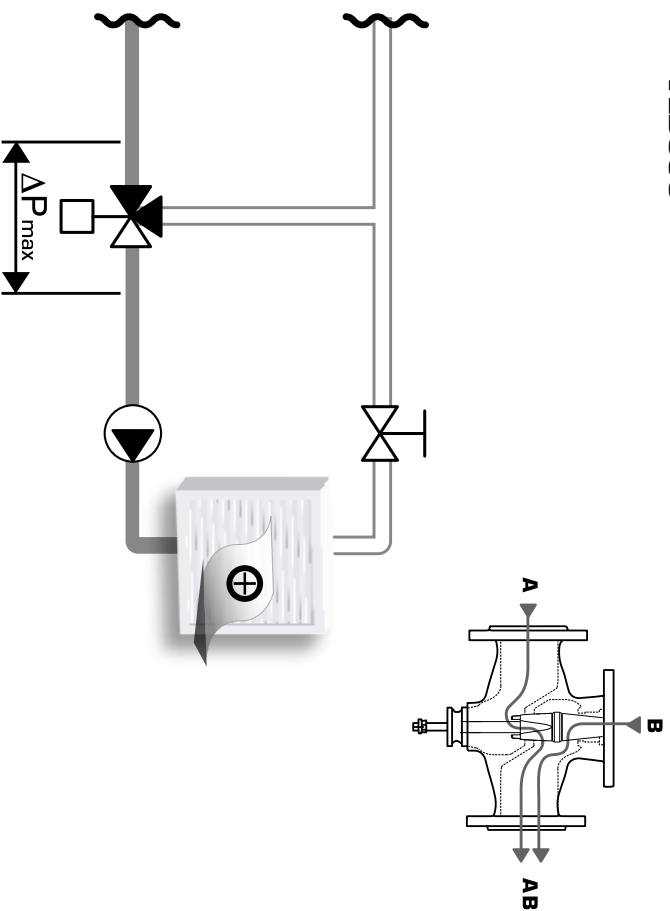
*Piping Schematics are General Representations*