



**SERIES VRG230**



Mtrl.nr: 9814 02 72 • Ritn.nr: 7048 utg C • Rev. 1605



Series VRG231  
Series VRG232  
Series VRG233  
Series VRG238

CE  
PED 2014/68/EU, article 4.3

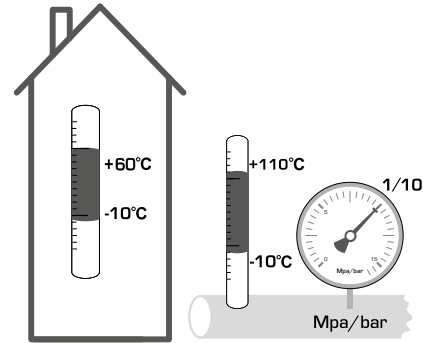

**1**

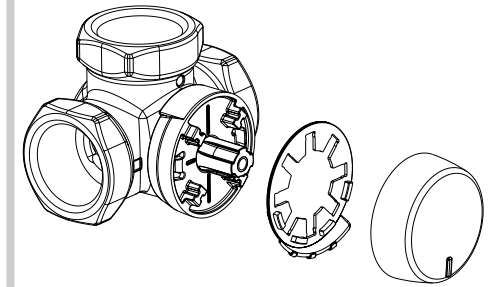

**i**

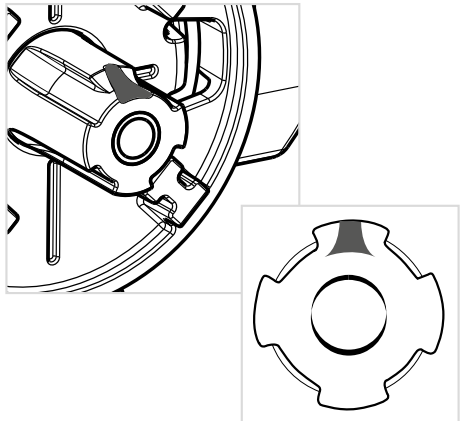

**i**

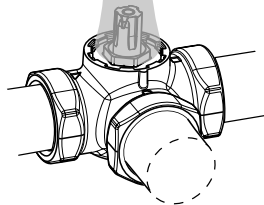
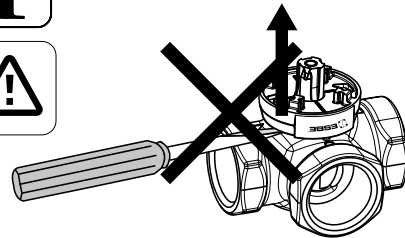

Piping Schematics are General Representations

**2**

**a**

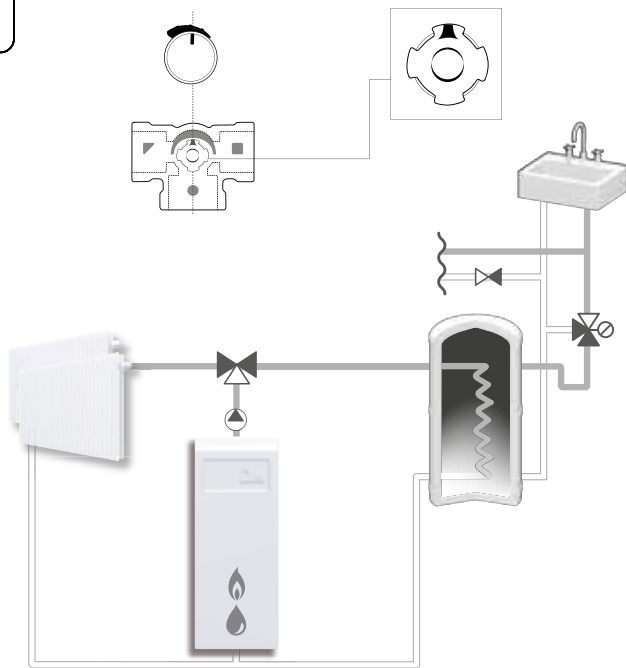

**b**

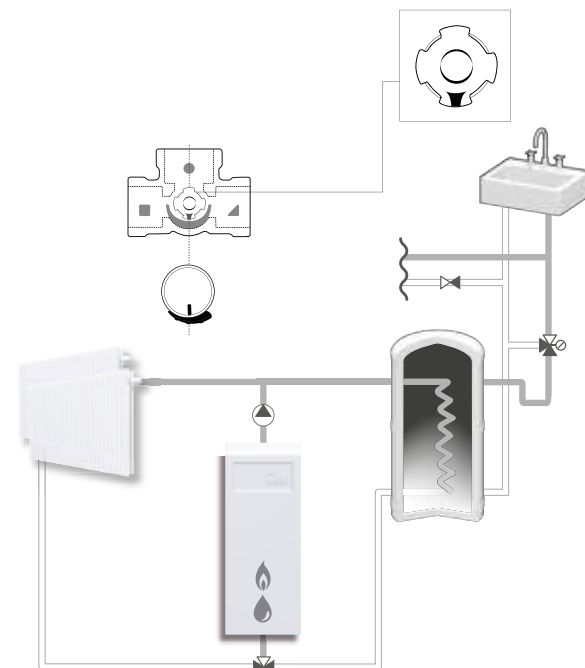

**i**



<http://www.esbe.eu/global/en/products/rotary-valves>